



Leica DMI3000 B, DMI4000 B, DMI6000 B

Instructions · Bedienungsanleitung · Mode d'emploi



Living up to Life

Leica
MICROSYSTEMS

Revision 1.1, published 30. August 2012 by:

Revision 1.1, herausgegeben 30. August 2012 von:

Révision 1.1, publiée le 30 août 2012 par :

Leica Microsystems CMS GmbH

Ernst-Leitz-Straße 17-37

D-35578 Wetzlar (Germany)

<http://www.leica-microsystems.com>

Responsible for contents:

Verantwortlich für den Inhalt:

Responsable du contenu rédactionnel :

Marketing CMS, Product Management

Marketing CMS, Produktmanagement

Marketing CMS , Product Management



Leica DMI3000 B, DMI4000 B, DMI6000 B

Instructions

CE

Living up to Life

Leica
MICROSYSTEMS

Copyrights

All rights to this documentation are held by Leica Microsystems CMS GmbH. Reproduction of text or illustrations (in whole or in part) by print, photocopy, microfilm or other method (including electronic systems) is not allowed without express written permission from Leica Microsystems CMS GmbH.

The term „Windows“ may appear in the following text without further identification. It is, however, a registered trademark of Microsoft Corporation. The names of companies and products used herein may be trademarks of their respective owners.

The instructions contained in the following documentation reflect state-of-the-art technology standards. We have compiled the texts and illustrations as accurately as possible. Still, we are always grateful for comments and suggestions regarding potential mistakes within this documentation.

The information in this manual is subject to modification at any time and without notification.

Contents

1. Important Notes about this Manual.....	7
1.1 Text symbols, pictograms and their meanings	7
2. Intended Purpose of the Microscope	9
3. Safety Notes.....	10
3.1 General Safety Notes.....	10
3.2 Electrical Safety.....	11
3.3 Transport and storage	13
3.4 Safety Instructions for Handling the Light Sources	13
3.5 Notes on handling laser devices	13
3.6 Notes on handling immersion oil	13
3.7 Safety Instructions for Handling Acids and Bases.....	14
3.8 Disposal.....	14
3.9 Type labels.....	14
4. Overview of the Leica DMI Series.....	15
5. Unpacking the Microscope	28
6. Assembling the Microscope.....	31
6.1 Assembly Tools	31
6.2 Installation of the Transmitted Light Illumination Carrier (TL).....	32
6.3 Installation of the DIC Module and DIC Objective Prisms.....	33
6.4 Installation of Specimen Stages.....	34
6.5 Installation of Condensers	39
6.6 Installation of Eyepieces	44
6.7 Installation of Objectives.....	44
6.8 Installation of Filters in the Illumination Arm.....	45
6.9 Installing the transmitted Light Lamp Housing	45
6.10 Installation and Replacement of the transmitted Light Lamps: 107 or 107/2 Lamp Housing.....	46
6.11 Installing the Lamp Housing Mount and Mirror Housing (Leica DMI4000 B and DMI6000 B)	47
6.12 Installation and Replacement of Incident Light Lamps	49
6.13 Equipping the Incident Light Turret Disk...	53
6.14 Inserting the Front Module Slider.....	56
6.15 Installation of the Polarizer and Analyzer.....	56
6.16 Optional Accessories.....	58
6.17 Connection to the Electronics Box CTR4000, CTR5000, CTR5500, CTR6000, CTR6500, CTR7000, CTR6500 HS, CTR7000 HS.....	59
6.18 Connection to the Computer.....	60
6.19 Connection to the Power Supply	60
7. Start-up	61
7.1 Functional Principle (Leica DMI4000 B and Leica DMI6000 B).....	61
7.2 Switching on the Microscope	65
7.3 The LeicaDisplay (Leica DMI4000 B and DMI6000 B)	66
7.4 The Function Buttons on the Stand.....	67
7.5 The SmartMove Remote Control Module..	70
7.6 Illumination	70
7.6.1 Transmitted light.....	70
7.6.2 Incident Light - Fluorescence	73
7.7 Checking Phase Contrast Rings.....	74
7.8 Checking modulation contrast slit diaphragms.....	78
7.9 Setting the Motorized Polarizer	78
7.10 Adjusting the Light Sources	79

8. Operation	82	9. Trouble Shooting	106
8.1 Switching on.....	82	10. Care of the Microscope	110
8.2 Contrast Methods.....	84	10.1 Dust Cover.....	110
8.2.1 Bright Field (TL).....	84	10.2 Cleaning.....	110
8.2.2 Phase Contrast (TL).....	86	10.3 Handling Acids and Bases.....	111
8.2.3 Dark Field (TL).....	87	11. Major Consumable and Replacement	
8.2.4 Polarization (TL).....	88	Parts	112
8.2.5 Differential Interference		12. Dimensions	113
Contrast (TL).....	89	13. Abbreviations and Pictograms	114
8.2.6 Integrated Phase Contrast (TL).....	90	14. Index	116
8.2.7 Integrated Modulation		15. EU Declaration of Conformity	118
Contrast (TL).....	91		
8.3 Fluorescence.....	92		
8.4 Combination Methods.....	94		
8.5 Focusing.....	95		
8.6 Tubes.....	97		
8.7 Port selection.....	97		
8.8 Eyepieces.....	98		
8.9 Objectives.....	99		
8.10 Stages and Object Displacement.....	102		
8.11 Magnification Changer.....	103		
8.12 Light sources.....	104		
8.13 Aperture and Field Diaphragm.....	105		

1. Important Notes about this Manual



Caution!

This operating manual is an essential component of the microscope, and must be read carefully before the microscope is assembled, put into operation or used.

This operating manual contains important instructions and information for the operational safety and maintenance of the microscope and accessories. It must therefore be kept safely for future reference.

A separate manual is available on CD-ROM covering the operation of the Leica Application Suite (LAS).

1.1 Text symbols, pictograms and their meanings

(1.2)

Numbers in parentheses, such as „(1.2)“, correspond to illustrations (in the example, Figure 1, Item 2).

→ p. 20

Numbers with pointer arrows (for example → p. 20), point to a certain page of this manual.



Explanatory note.

*

Item not contained in all configurations.



Notes on the disposal of the microscope, accessories and consumable materials.



Device for in vitro diagnostics.



MM/YYYY

IVD manufacturing date, example 11 / 2011 for November 2011.

1. Important Notes about this Manual



Caution!

Special safety instructions within this manual are indicated with the triangle symbol shown here, and have a gray background.



Caution! The microscope and accessories can be damaged when operated incorrectly.



Warning of hot surface!



Ground/Earth terminal!



Caution - High voltage! Risk of electrical shock!!



Warning: Before opening disconnect mains.



China RoHS 50 years EFUP
(Environmentally friendly use period)

2. Intended Purpose of the Microscope

The Leica DMI Series microscopes covered in this manual are designed for biological, routine, and research applications. This includes the examination of samples taken from the human body in order to provide information on physiological or pathological states or congenital abnormalities; to determine the safety and compatibility with potential recipients; or to monitor therapeutic measures.

The Leica DMI Series is an additional development of Leica's proven inverted research microscopes, designed for cellular and tissue examination, micromanipulation and microinjection techniques, microdissection, and confocal microscopy. The Leica DMI Series is suitable for universal deployment. All contrast methods such as dark field, bright field, phase contrast, DIC, fluorescence, and modulation contrast are integral to the microscope and can be adapted or changed quickly and easily. Variable illumination and imaging beam paths, as well as HCS optics, modular accessories, and a comprehensive range of peripherals complement the Leica Microsystems inverted research stand.

IVD

The above-named microscopes comply with the Council Directive 98/79/EEC concerning in vitro diagnostics.



Caution!

The manufacturer assumes no liability for damage caused by, or any risks arising from, using the microscopes for purposes other than those for which they are intended or not using them within the specifications of Leica Microsystems CMS GmbH.

In such cases the declaration of conformity shall cease to be valid.



Caution!

These (IVD) devices are not intended for use in the patient environment defined by DIN VDE 0100-710. Neither are they intended for combining with medical instruments according to EN 60601-1. If a microscope is electrically connected to a medical instrument according to EN 60601-1, the requirements defined in EN 60601-1-1 shall apply.

Not suitable for examining potentially infectious specimens.

Only trained personnel may operate this type of device.

3. Safety Notes

3.1 General Safety Notes

These safety class 1 instruments were built and tested in accordance with the harmonized standards

EN 61010-1:2002-08,

EN 61326-1:2006,

IEC 61010-1:2001-02,

UL 61010-1:2004,

Safety regulations for electrical measuring, control, and laboratory devices and

EN 61010-2-101:2002-11,

IEC 61010-2-101:2002-01

Safety regulations for electrical measuring, control, and laboratory devices, part 2 special requirements concerning in vitro diagnostics (IVD) medical instruments.



Caution!

The devices and accessories described in this operating manual have been tested for safety and potential hazards.

The responsible Leica affiliate or the main plant in Wetzlar must be consulted whenever the device is altered, modified or used in conjunction with non-Leica components that are outside of the scope of this manual.

Unauthorized alterations to the device or noncompliant use shall void all rights to any warranty claims and product liability!



Caution!

In order to maintain this condition and to ensure safe operation, the user must follow the instructions and warnings contained in this operating manual.

3.2 Electrical Safety

General Specifications

Leica CTR4000, CTR5000, CTR5500, CTR6000, CTR6500, CTR7000, CTR6500 HS, CTR7000 HS Electronics Boxes

For indoor use only.

Supply voltage:	100–240 V AC
Frequency:	50/60 Hz
Power input:	max. 290 W
Fuses:	T6.3 A (IEC 60127-2/3)
Ambient temperature:	15–35°C
Relative humidity:	max. 80% to 30°C non-condensing
Over voltage category:	II
Pollution degree:	2

Microscope

For indoor use only.

Supply voltage:	100–240 V AC
Frequency:	50/60 Hz
Power input:	See CTR4000–7000 HS
Fuses:	See CTR4000–7000 HS
Ambient temperature:	15–35°C
Relative humidity:	max. 80% to 30°C non-condensing
Over voltage category:	II
Pollution degree:	2

ebq 100 supply unit*

For indoor use only.

Supply voltage:	100–240 V AC
Frequency:	50/60 Hz
Power input:	max. 155 W
Fuses:	2xT2A (IEC 127)10–
Ambient temperature:	36°C
Relative humidity:	max. 80% to 30°C non-condensing
Over voltage category:	II
Pollution degree:	2
(see enclosed manual)	

Leica EL6000*

For indoor use only.

Supply voltage:	100–240 V AC
Frequency:	50/60 Hz
Power input:	max. 200 W
Fuses:	5x20, 2.5 A, slow, breaking capacity H
Ambient temperature:	0°–40°C
Relative humidity:	10–90% non-condensing
Overvoltage category:	II
Pollution degree:	2
(see enclosed manual)	

3. Safety Notes

3.7 Safety Instructions for Handling Acids and Bases

For examinations using acids or other aggressive chemicals, particular caution must be taken.



Caution!

Be absolutely certain to prevent coming into contact with these chemicals.

3.8 Disposal

To dispose of the product at the end of its service life, please contact Leica Service or Sales.

Please observe national laws and regulations, such as those implementing and enforcing the WEEE EU Directive.



Note!

Like other electronic devices, the microscope, its accessories and consumable materials must not be disposed of as regular household waste.

3.9 Type labels

Type label Leica DMI3000 B



Type label Leica DMI4000 B



Type label Leica DMI6000 B



4. Overview of the Leica DMI Series

4.1 Specifications

Contrast Methods	<p><u>Leica DMI Series</u></p> <ul style="list-style-type: none"> transmitted light (TL): BF, DF, PH, DIC, PoI intermediate pupil: IMC (integrated modulation contrast) IPH (Integrated phase contrast) incident light (IL): Fluo <p><u>Leica DMI4000 B and DMI6000 B</u></p> <ul style="list-style-type: none"> combination (TL/IL): Fluo/DIC, Fluo/PH
Transmitted Light Axis	<p><u>Leica DMI Series</u></p> <ul style="list-style-type: none"> Manual and coded transmitted light illumination arm with integrated mechanical tilt mechanism to provide adequate space for specimens and micromanipulators, integrated field diaphragm, filter magazine for 2 replaceable filters, condenser quick-changer Illumination Manager (aperture diaphragm, field diaphragm, light intensity) manual shutter lamp housing mount for interchangeable lamp housings. with integrated cable channel <p><u>Leica DMI4000 B and Leica DMI6000 B</u></p> <ul style="list-style-type: none"> Motorized or manual/coded transmitted light illumination arm with integrated mechanical tilt mechanism to provide adequate space for specimens and micromanipulators, integrated motorized field diaphragm, motorized filter magazine for 2 replaceable filters, condenser quick-changer with integrated cable channel automatic Illumination Manager (aperture, field diaphragm, intensity, process switching) manual or motorized shutter lamp housing mount for interchangeable lamp housings. automatic, electronic condenser identification

4. Overview of the Instruments

<p>Incident Light Axis</p>	<p><u>Leica DMI3000 B</u></p> <ul style="list-style-type: none"> • manual shutter • lamp housing mount for up to 3 interchangeable light sources • manual 5-place filter turret • Fluorescence Intensity Manager (FIM) (reduction of incident illumination intensity) <p><u>Leica DMI4000 B and Leica DMI6000 B</u></p> <ul style="list-style-type: none"> • automatic Illumination Manager (aperture, field diaphragm*, intensity, process switching) • motorized shutter (switching speed < 50 ms) • lamp housing mount for up to 3 interchangeable light sources • motorized 6-place filter turret • Fluorescence Intensity Manager (FIM) (reduction of incident illumination intensity) • Optional: Interface for structured illumination • <u>Leica DMI6000 B:</u> mechanical booster lens for central boosting of fluorescence or uniform distribution • motorized Excitation Manager* to monitor fluorescence emission when using double and triple filter cubes • ultra fast filter wheel for 3 excitation wavelengths (switching speed < 50 ms)
<p>Tube</p>	<p><u>Leica DMI Series</u></p> <ul style="list-style-type: none"> • ergonomic with or without camera port at left • 2 switching positions: 100%VIS and 50%VIS / 50%CAM or • 2 switching positions: 100%VIS and 0%VIS / 100%CAM • optional Bertrand lens • eye spacing adjustment • height and angle adjustment (30° - 45°)
<p>Magnification Changer</p>	<p><u>Leica DMI4000 B and Leica DMI6000 B</u></p> <ul style="list-style-type: none"> • motorized • 3 switching positions (choice of magnifications: 1x; 1.5x; 1.6x or 2.0x) • effective on all camera ports and eyepieces <p>or <u>Leica DMI Series</u></p> <ul style="list-style-type: none"> • manual • 2 switching positions (choice of magnifications: 1x; 1.5x; 1.6x or 2.0x) • effective on tube port and eyepieces

* not in combination with structured illumination

Objective Turret	<p><u>Leica DMI6000 B</u></p> <ul style="list-style-type: none"> • motorized and coded • 6x for objectives with M25 thread and 45 mm parfocal distance • for DIC: motorized or manual/coded Wollaston prism carousel • anti-vibration locking <p><u>Leica DMI4000 B</u></p> <ul style="list-style-type: none"> • manual and coded • 6x for objectives with M25 thread and 45 mm parfocal distance • for DIC: motorized or manual/coded Wollaston prism carousel <p><u>Leica DMI3000 B</u></p> <ul style="list-style-type: none"> • manual • 6x for objectives with M25 thread and 45 mm parfocal distance • for DIC: manual Wollaston prism carousel
Stages	<p><u>Leica DMI Series</u></p> <p>Fixed regular stages</p> <ul style="list-style-type: none"> • Ceramic-coated stage plate (248 mm x 204 mm) <ul style="list-style-type: none"> • heating stage plate (3°C above room temperature to 60°C) (248 x 212 mm) • temperature-controlled stage plate (0°C to 60°C) (248 mm x 212 mm) • fixed micromanipulation stages <ul style="list-style-type: none"> • ceramic-coated stage plate (248 mm x 204/122 mm) • heated stage plate (from 3°C above room temperature to 60°C) (248 mm x 204/122 mm) • temperature-controlled stage plate (0°C to 60°C) (248 mm x 204/122 mm) • regular manual and motorized 3-plate cross-stage <ul style="list-style-type: none"> • positioning range: 83 mm x 127 mm • 20 optional inserts (standard, heating, cooling) for a variety of applications, size of inserts:160 mm x 110 mm (compatible with scanning stages) • narrow manual and motorized micromanipulation 3-plate cross-stage <ul style="list-style-type: none"> • positioning range: 40 mm x 40 mm • 3 optional inserts for a variety of applications • Scanning stage 120 x 100 (motors on bottom) <ul style="list-style-type: none"> • 1 mm, 2 mm, 4 mm spindle pitch (higher resolution vs. higher speed) • 20 optional inserts (standard, heating, cooling) for a variety of applications, size of inserts:160 mm x 110 mm

4. Overview of the Instruments

<p>Condensers</p>	<p><u>Leica DMI4000 B and Leica DMI6000 B</u> (identical for Leica DMI3000 B, but manual)</p> <ul style="list-style-type: none"> • motorized and coded or manual and coded • motorized or manual aperture diaphragm • contrast methods: BF, DF, PH, DIC, Pol, IMC, IPH • automatic method switching • condenser turret with 7 positions for contrast methods • 2 condenser housings (S1-S28 and S40,S70) • condenser heads: S1/1.4 oil, S1/0.9 dry, S23/0.53, S28/0.55 • condenser heads can be swung out • condenser S40/S70 with additional lens for low magnifications • all condensers suitable for magnifications from 1.25x to 100x • with or without motorized or manual polarizer • with or without motorized or coded Wollaston prism disk
<p>Z Focus</p>	<p><u>Leica DMI6000 B</u></p> <ul style="list-style-type: none"> • motorized and coded • 9 mm travel (1 mm below, 8 mm above the stage) • maximum travel speed: 5 mm/s • 5 focus steps: 0.05 μm; 0.1 μm; 0.7 μm; 1.5 μm; 5.0 μm • electronic focus repositioning • automatic lowering prior to objective change • electronic parfocality • Optional: Adaptive Focus Control (AFC) <p><u>Leica DMI3000 B and Leica DMI4000 B</u></p> <ul style="list-style-type: none"> • manual • 9 mm travel (1 mm below, 8 mm above the stage)
<p>Observation Ports</p>	<p><u>Leica DMI6000 B</u></p> <ul style="list-style-type: none"> • motorized and coded <ul style="list-style-type: none"> • left side ports (100%, 80% or 50% transmission) • left side port dichroic splitting at 680 nm • right side ports (100%, 80% or 50% transmission) • bottom port <p>optional</p> <ul style="list-style-type: none"> • top port with 2 switching positions <ul style="list-style-type: none"> • 100% to eyepieces • 50% to eyepieces/ 50% to port <p><u>Leica DMI4000 B</u> left side port, manual (100% or 80% transmission)</p>

Observation Ports	<u>Leica DMI3000 B</u> (a manual side port is a standard feature of the Leica DMI3000 B stand) <ul style="list-style-type: none"> • manual • left side port (80% or 100% transmission)
Controls	<u>Leica DMI4000 B and Leica DMI6000 B</u> <ul style="list-style-type: none"> • 7 fixed control buttons for illumination and apertures • 7 variable function buttons behind the focus controls • 3 fixed control buttons for focus stops (Leica DMI6000 B only) • 2 focus hand wheels • 7 buttons for fluorescence cubes and shutters • 4 buttons for magnification changer and ports • SmartMove: ergonomic remote control module for x,y,z control and four additional variable function buttons • STP6000 <u>Leica DMI3000 B</u> <ul style="list-style-type: none"> • 2 focus hand wheels • 1 illumination hand wheel • 2 turning knobs for field diaphragm and FIM adjustment • 1 On/Off switch
Electronics Box	<ul style="list-style-type: none"> • separate control unit for all motorized and electronic elements of the microscope such as: <u>For CTR6500 (HS)/CTR7000 (HS) only</u> <ul style="list-style-type: none"> • scanning stages <u>For CTR6000 only</u> <ul style="list-style-type: none"> • motorized 3-plate cross-stages <u>For CTR6000/7000</u> <ul style="list-style-type: none"> • objective turret • focus • ports • magnification changer • fluorescence • condenser • power supply for SmartMove <u>For all CTR boxes</u> with <ul style="list-style-type: none"> • power supply for 100W halogen lamps

4. Overview of the Instruments

Interfaces	<u>Leica DMI4000 B and Leica DMI6000 B</u> <ul style="list-style-type: none">• 2 x RS232C• 2 x USB• 4 x external/internal peripherals• CTR boxes• SmartMove• STP6000
Software Tools	<u>Leica DMI4000 B and Leica DMI6000 B</u> <ul style="list-style-type: none">• Leica Application Suite (LAS) for Windows™ with plug-ins for:<ul style="list-style-type: none">• microscope and camera configuration• microscope and camera control• image acquisition

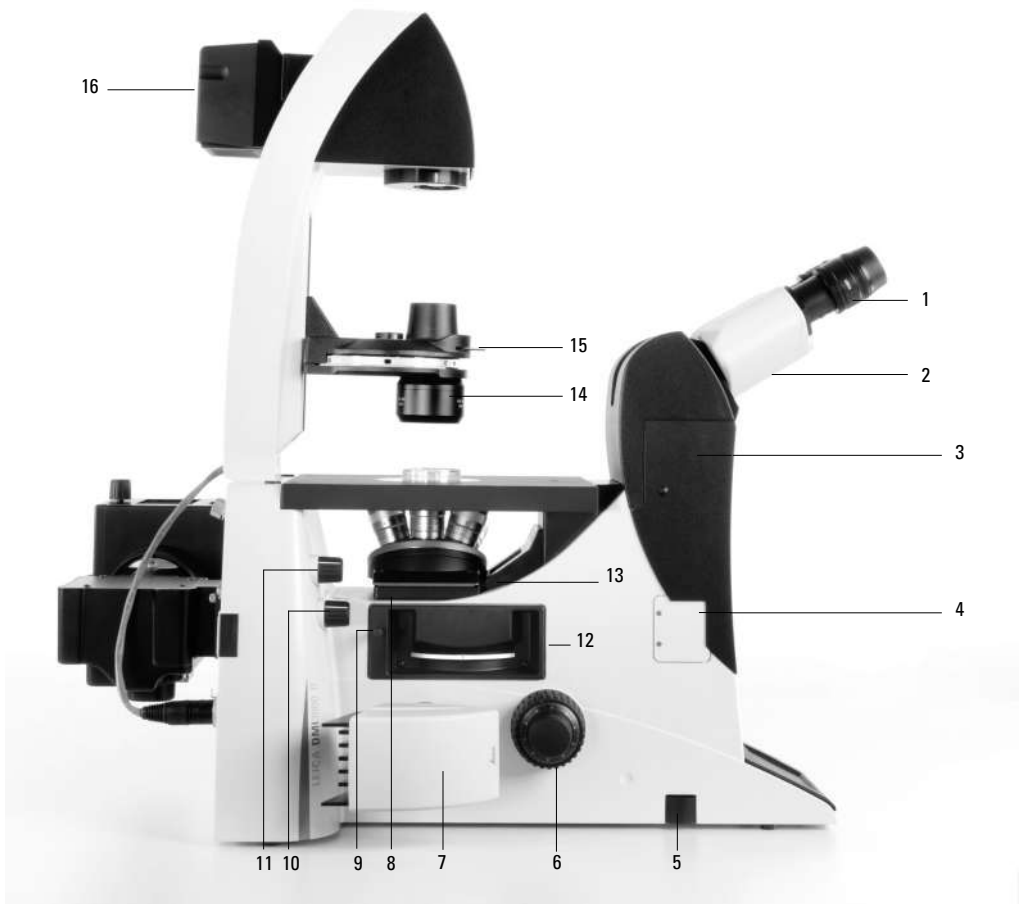

Fig. 5a Leica DMI3000 B left view

- | | |
|---|---|
| <ul style="list-style-type: none"> 1 Eyepiece 2 Eyepiece tube 3 Top port 4 Intermediate pupil interface 5 Light intensity 6 Focus wheel 7 Left side port with camera 8 Objective turret | <ul style="list-style-type: none"> 9 Filter slider 10 Adjustment FIM 11 Adjustment field diaphragm 12 Drawer (fluorescence microscopes only) 13 DIC objective prism disk 14 Condenser head 15 Condenser base 16 Integrated 30W transmitted light lamp housing |
|---|---|

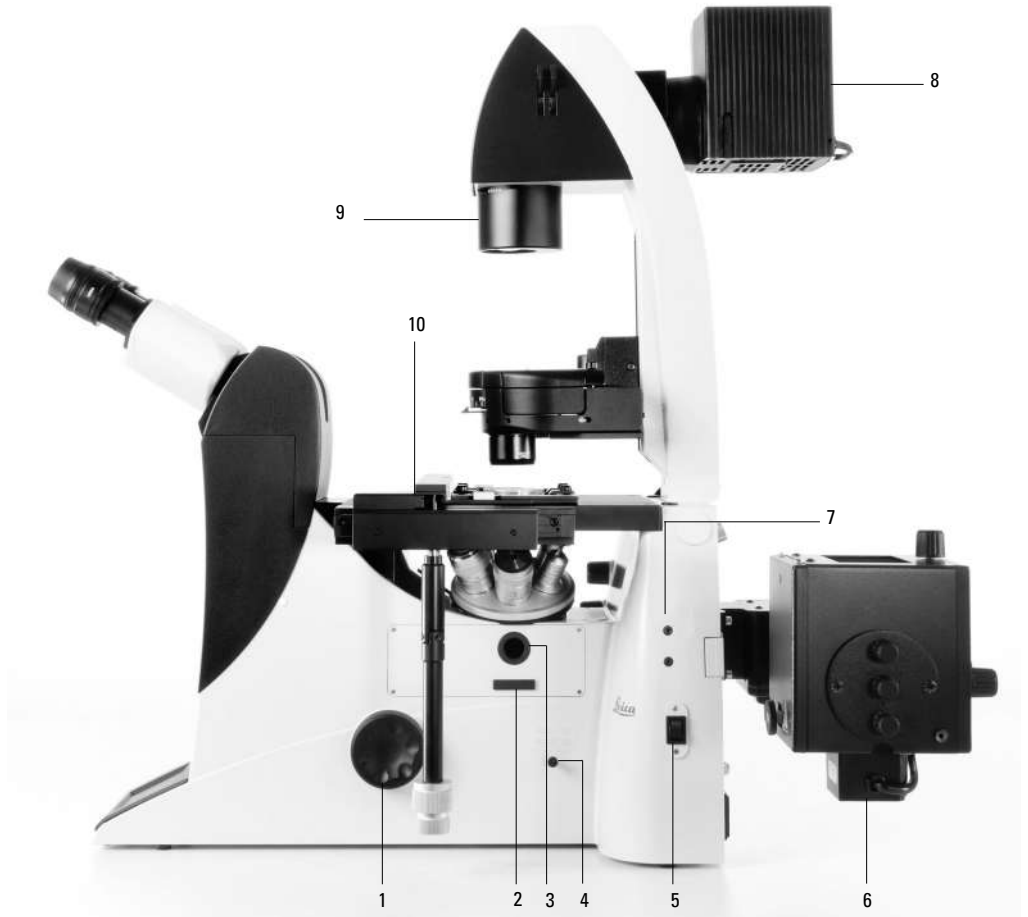

Fig. 5b Leica DMI3000 B right view

- 1 Focus wheel
- 2 Analyzer slot
- 3 Centering window (fluorescence microscopes only)
- 4 Port switching
- 5 On/Off switch
- 6 Incident light lamp housing (fluorescence microscopes only)
- 7 Field diaphragm centering
- 8 Transmitted light lamp housing
- 9 Field diaphragm
- 10 Stage with attachable mechanical stage

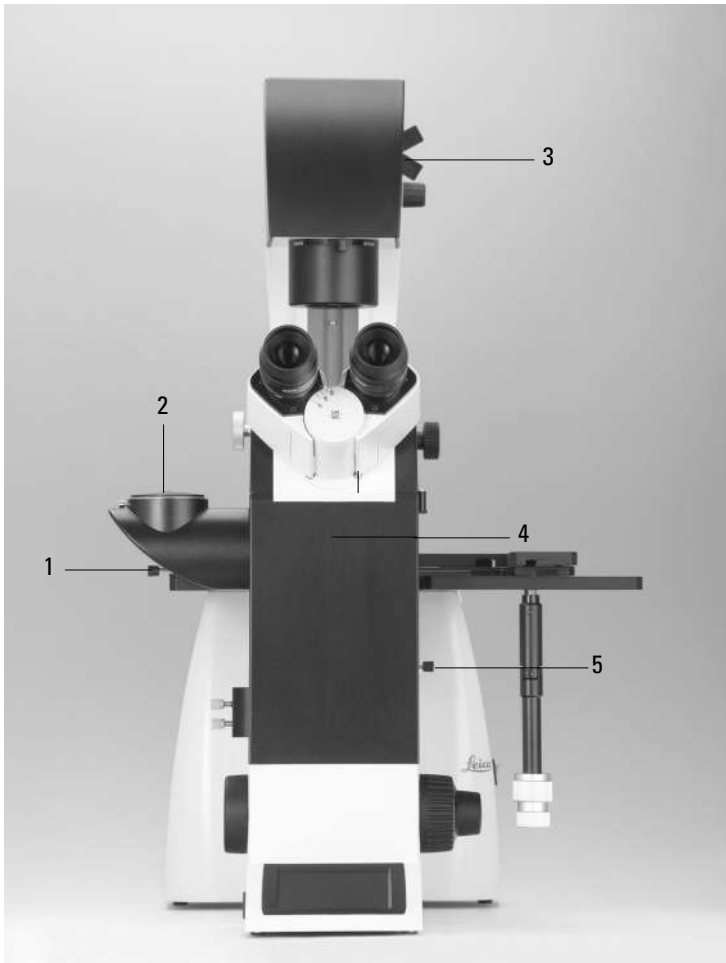

Fig. 6 Leica DMI3000 B front view

- 1 Port switching and Bertrand lens
- 2 Top port
- 3 Manual transmitted light filters
- 4 Bertrand lens centering
- 5 Manual magnification changer

5. Unpacking the Microscope

The microscope is delivered in several packages.

The **stand package** contains the following components:

- Stand with integrated incident light axis, objective turret, and tube
- Illumination arm
- Specimen stage
- CD with Leica Application Suite (LAS) software package
- Instructions and list of microscope presets (identification sheet)

The **system package** contains the microscope's accessories:

- Eyepieces
- Objectives
- Condenser
- Lamp housings with accessories
- Assembly tools
- Additional accessories such as filter cubes, etc. depending on feature set

The Leica CTR4000, CTR5000, CTR5500, CTR6000, CTR6500, CTR7000, CTR6500 HS, CTR7000 HS electronics box, the SmartMove, STP6000 remote control module, movable stages, stage accessories, the external ebq 100 supply unit and the compact light source Leica EL6000 are provided in separate packages.

Please carefully compare the contents of the delivery to the packing slip, delivery note or invoice. We strongly recommend storing a copy of these documents with the manual to ensure that you have information on the date and scope of delivery handy for subsequent orders or service work. Please ensure that no small parts remain in the packing material. Parts of the packing material are marked by symbols to simplify recycling.

First, carefully remove all components from the transportation and packaging materials.



Caution!

Do not put the instrument into operation in the event of visible damage to the components or packing material.



Note:

If at all possible, avoid touching the lens surfaces of the objectives. If fingerprints do appear on the glass surfaces, remove them with a soft leather or linen cloth. Even small traces of finger perspiration can damage the surfaces in a short time. See the chapter „Care of the Microscope“ → p. 110, for additional instructions.



Caution!

Do not connect the microscope or peripherals to an AC power source at this time under any circumstances!

Installation Location

Work with the microscope should be performed in a dust-free room, which is free of oil vapor and other chemical vapor, as well as extreme humidity. At the workplace, large temperature fluctuations, direct sunlight, and vibration should be avoided. These may adversely affect measurements and long-term observations.

Allowable ambient conditions

Temperature 15–35°C

Relative humidity maximum 80% up to 30°C
non-condensing

Microscopes in warm and warm-damp climatic zones require special care in order to prevent the build up of fungus.

See the chapter „Care of the Microscope“ → p. 110, for additional instructions.



Caution!

Electrical components must be placed at least 10 cm from the wall and away from flammable substances.



Caution!

When installing the microscope, make sure the power inlet is freely accessible so that the instrument can be quickly disconnected from the mains if necessary.

5. Unpacking the Microscope

Transport

For shipping or transporting the microscope and its accessory components, the original packaging should be used.

As a precaution to prevent damage from vibrations, the following components should be disassembled and packaged separately:

- Unscrew the objectives.
- Remove the eyepieces.
- Remove the condenser.
- Remove the specimen stage.
- Remove the transmitted-light arm.
- Remove the lamp housings.
- Remove the lamp housing mount.
- Disassemble the burner of 106 z lamp housing.
- Remove the filter cube.
- Remove all moving or loose parts.

Weight

The weight of the microscope depends on the particular equipment.

Fully equipped, the microscope weighs more than 18 kg. For transportation, the user has to take care of the corresponding actions.



Caution!

For transporting it is essential to remove all components listed under "Transport"!

6. Assembling the Microscope

The microscope components* are logically assembled in this order:

- Transmitted light illumination carrier
- DIC module and DIC objective prisms
- Condenser with condenser head
- Eyepieces
- Objectives
- Transmitted light lamps
- Lamp housing mount (mirror housings)
- Incident light lamps
- Assembly of incident light turret disk
- Specimen stage
- Polarizer and analyzer

The order may vary when using climate chambers or other systems and optical accessories.

In this case, read Chapter „6.16 Optional Accessories“ → p. 58.

6.1 Assembly Tools

If possible, the microscope should be assembled and set up with the assistance of Leica sales or service personnel.

A small number of universal screwdrivers which are included in the scope of delivery are required for assembly (Fig. 7).

Fig. 7 Assembly tools

- 1 Phillips screwdriver*
- 2 3 mm Allen key
- 3 1.5 mm centering key*
- 4 2 mm centering key*
- 5 3 mm hex key*
- 6 2.5 mm hex key* (short type)
- 7 2.5 mm hex key*

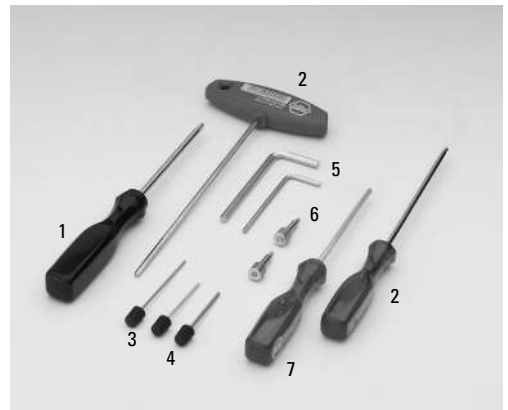

* depending on scope of delivery

6. Assembly

6.2 Installation of the Transmitted Light Illumination Carrier (TL)

Wipe the installation surface on the microscope (8.3) with a dry cloth. Tip the illumination carrier (8.1) back slightly and install it so that the pin (8.2) engages the groove in the support surface (8.4).

Set the TL illumination carrier upright and fasten it with the 4 screws.

When fastening the transmitted light illumination carrier, do not hold it. This will ensure its optimal alignment with the optical axis.

The tilt angle of the illumination carrier can be varied with the knurled screw (9.1) or fixed vertically.

Fig. 8 Installing the transmitted light illumination carrier

- 1 Transmitted light illumination carrier
- 2 Transmitted light illumination carrier pin
- 3 Support surface
- 4 Support surface groove
- 5 Support surface groove
- 6 EXT1-EXT4 sockets
- 7 Connector cable

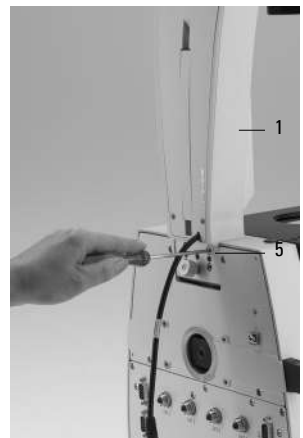
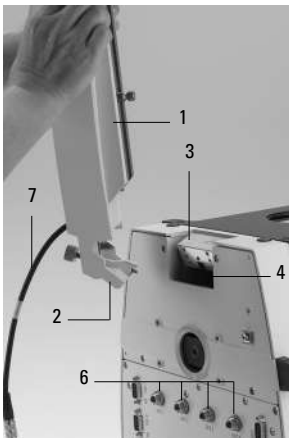

Leica DMI4000 B and Leica DMI6000 B

Connect the electronics cable to one of the sockets, EXT1 – EXT4.

The transmitted light lamp housing for 12 V 100 W halogen lamps is a separate component. For instructions on replacing the halogen lamp → Ch. 6.10, p. 46.

Fig. 9 Transmitted light illumination carrier, rear side

- 1 Knurled locking knob of the transmitted light illumination carrier
- 2 Connector cable for the microscope rear side

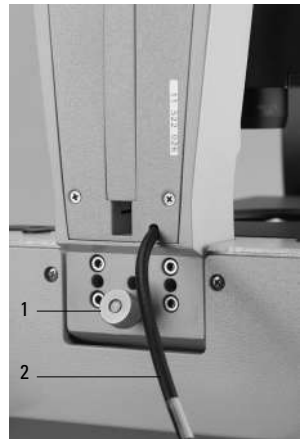

6.3 Installation of the DIC Module and DIC Objective Prisms

If your microscope is not equipped with DIC, please continue with Chapter 6.4.

In the Leica DMI series microscopes, the DIC prisms are already installed in the DIC disk below the objective turret (Fig. 10b). Motorized, manual coded and manual DIC disks are available. The installation is identical for all types.

Proceed as follows when making changes to the IC prism disk:

- Remove the front cover (Fig. 11) below the objective revolver after releasing the socket screws (Fig. 10a).

Fig. 10a Removing the front cover



Fig. 11 Front cover, DIC prism disk



Fig. 12 IC objective prism

- 1 Objective prism in frame
- 2 Screw and washer



- Insert the DIC prism disk (Fig. 10b) squarely in its receptacle. First, lightly tighten one screw with the included 3 mm hex screwdriver, then tighten both Allen screws.

Note: insert the prism disk with the electronics board facing down. Do not touch the electronics (especially the contacts) with your bare fingers!

Replacing Individual IC Prisms:

- Release the two socket screws and remove the prism disk.
- Place the prism against the stop pin (10b.3), place the washer between the screw and the prism, and tighten gently to prevent undue tension. Insert the prism so that its identifying letter, e.g. ID, is facing upward and is legible.
- After installing the prisms, replace the prism disk in its receptacle.

Fig. 10b DIC objective prism turret (coded and motorized)

- 1 IC objective prism in frame
- 2 Identification letter (ID)
- 3 Orientation pin

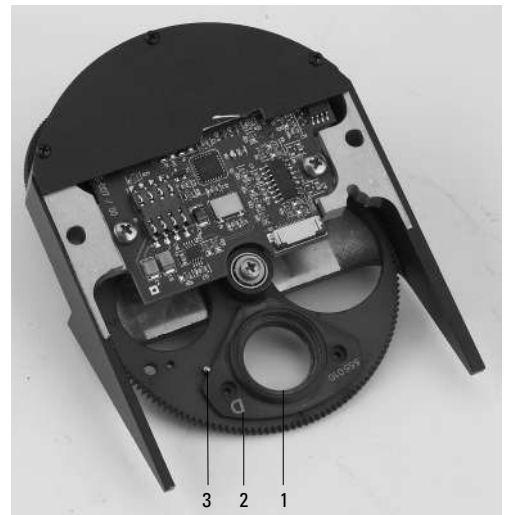

6. Assembly

6.4 Installation of Specimen Stages

A wide range of specimen stages are available. The most important are the following:

- Fixed stage (248 mm x 204 mm) (Fig. 13): normal, heating and temperature-controlled, with and without attachable mechanical stage
- Fixed micromanipulation stage (248 mm x 204/112 mm) (Fig. 15): normal, heating, and temperature-controlled, with and without attachable mechanical stage
- Standard manual (Fig. 14) and motorized 3-plate cross-stage, positioning range: 83 mm x 127 mm
- Manual (Fig. 15) and motorized micromanipulation 3-plate cross-stage positioning range: 40 mm x 40 mm
- manual rotating stage
- scanning stage 120 x 100 (motors on bottom)

Fig. 13 Fixed stage (normal)

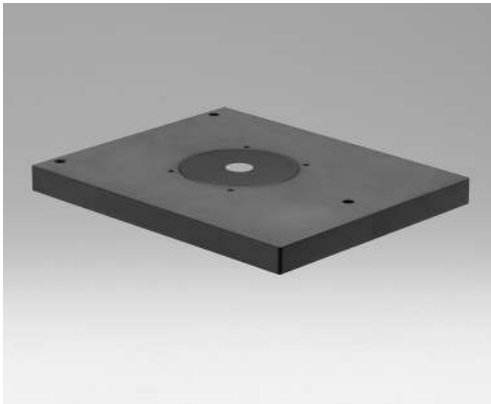

Fig. 14 Mechanical 3-plate stage



Fig. 15 Micromanipulation stage with attachable mechanical stage



Fig. 16 3-plate micromanipulation stage



The assembly of these stages is identical. The stages are solidly attached to the microscope by three screws. In the case of fixed stages, an attachable mechanical stage may be installed (Fig. 18). These are supplied in a separate package.

Multiple-plate stages are supplied separately. Like the fixed stages, these stages are mounted as follows:

- If the screws for the stage are already in the stand, remove them first. In most cases, the screws will be found in the packing material of the stand.



Caution!

The screw lengths may vary. When using screws of different lengths, use the shorter of the three screws in the front hole and the equally long ones in the rear holes.

- Use a clean cloth to remove dust and packing material residue from the stand's contact surface for the stage.
- Align the stage so that the pair of holes faces back toward the illumination axis and the single hole faces forward toward the tube.
- Align the mounting holes in the stage with the holes in the support surface. If the holes are covered in the case of 3-plate cross-stages or scanning stages, please shift the upper stage plate until the opening becomes visible.
- First, tighten the single front screw with the included 3 mm hex screwdriver. Be sure to use the shortest of the three screws in the front hole, as an excessively long screw can interfere with the focus travel.
- Next, firmly tighten the two rear screws.
- Finally, give the front screw a final firm tightening.

Fig. 17 Fixed micromanipulation stage

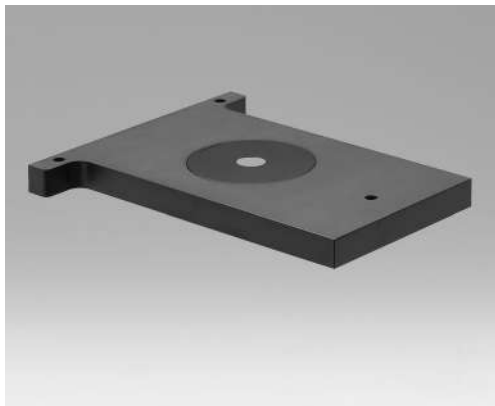

Fig. 18 Attachable mechanical stage for fixed micromanipulation stage



6. Assembly

Fixed Stage

Attachable mechanical stages designed to accept a variety of culture dishes are also available for fixed stages (Fig. 18).

Two screws are included with the attachable mechanical stage. Tighten these screws in the threaded holes on the underside of the fixed stage with the 3 mm hex screwdriver. Retighten these screws from time to time after frequent use.

The attachable mechanical stage has been pre-adjusted in the factory. In the event that the attachable mechanical stage runs out of focus when moving from right to left, this can be corrected by Leica's technical service.

Next, remove one or more of the ordered insert frames (Fig. 20) from their packaging and place

the insert frame into the precise retention system. The stage, the attachable mechanical stage, and the insert frame are now ready for use.

Some (not all) inserts are provided with self-adhesive scales to permit the coordinates to be read.

Apply these scales to the recesses of the attachable mechanical stage.

Fig. 19 a, b Inserts for attachable mechanical stage (fixed stage)

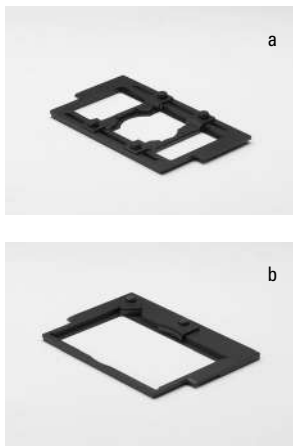
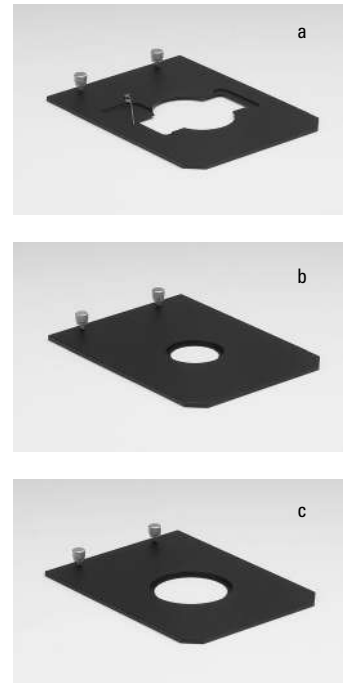

Fig. 20 a, b, c

Inserts for attachable mechanical stage (micromanipulation stage)



Manual Fixed Micromanipulation Stage

To install the attachable mechanical stage for the manual fixed micromanipulation stage (Fig. 24), proceed as you would for the attachable mechanical stage of the standard stage.

The insert frames (Fig. 20a to c) differ at this point. These are held by two screws on the attachable mechanical stage and changed by releasing the screws.

Fig. 21
Inserts for fixed stages

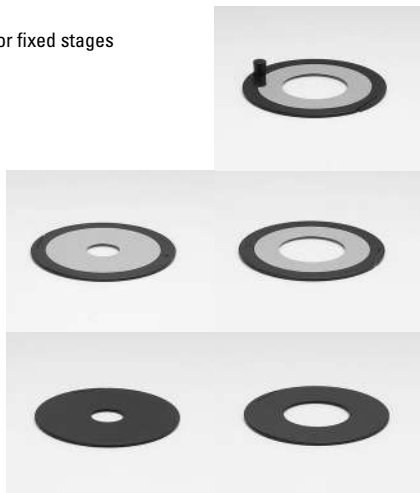

Fig. 22
Glass insert for
3-plate cross-stage
and scanning stage



Fig. 23
Heater insert



Fig. 24 Installation of attachable mechanical stage



Fig. 25 Installation of attachable mechanical stage



Motorized 3-plate or Scanning Stages

3-plate stages and scanning stages: after installing the stage, connect the included stage cable (for motorized stages) first to the socket on the stage, then to the CRT6000, CTR6500 or CTR7000 box. The correct place on the box is called „XY Stage“.

A variety of inserts (including heating ones) are available for the normal 3-plate and scanning stages. Install these inserts diagonally from above into the corner with the spring clips. The insert will click into place when seated properly.

! Caution:

Press the spring clip into place only from the side.

Do not press the insert onto the spring clips diagonally from above, as the insert will not be aligned parallel to the stage and may be bent in the process.

Fig. 29 a, b Mounting screws for 3-plate cross-stage

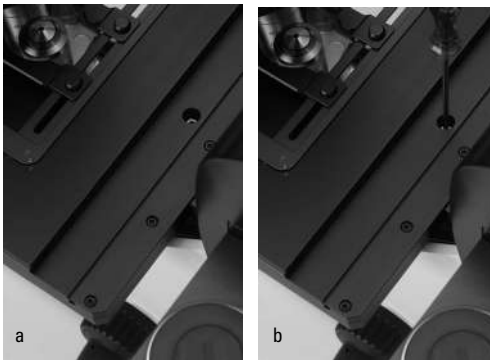

6.5 Installation of Condensers

All condensers of the Leica DMI Series are equipped with a 7-position turret disk that can be equipped with light rings phase contrast (PH) or dark field (DF), IC prisms for transmitted light interference contrast (DIC), or slit illuminators for integrated modulation contrast (IMC).

Light rings, slit diaphragms, and condenser prisms are generally already factory-installed in the turret, making the following assembly steps unnecessary. Please continue on → page 42, Installation of Condensers.

Installing the Light Rings and Slit Diaphragms

- Switch the microscope off.
- Remove the condenser cover (38.1). Insert the light ring in one of the condenser disk's large receptacles with guide grooves.
- Turn the right-hand centering screw back fully with the adjusting key (39.2). To prevent the condenser disk from turning further, insert the adjusting key (39.2) into the left-hand centering screw of the disk. It may protrude a **maximum of 1 mm** into the opening.

Fig. 33 Condenser base S1-S28



Insert light rings for Phaco (marked with the ID numbers 0, 1, 2, 3 and the focal intercept S of the corresponding condenser head), DF diaphragms (marked with a D for dark field and the focal intercept S of the corresponding condenser head), and slit diaphragms (marked M05, M10, M20, M40 and M63) in the location holes of the turret disk as follows:

- Select a position and ensure that the two mounting screws have been released to the point that they no longer extend into the position. To adjust the screws, turn the desired light ring position into the beam path. You can now turn the screws using the two adjusting keys.
- Next, take the special condenser tool (Fig. 39.1).
- If possible, install the light rings 0 to 3 in ascending order. The numbering of the openings is located at the edge of the crown gear (4 large openings: 1-4; 3 small openings: 5-7).

Fig. 34
Condenser head S1



Fig. 35
Condenser head S28



6. Assembly

- Grasp the light ring to be installed with the condenser tool (the lettering must face upward and be legible) so that the tab of the light ring is positioned to the center of the tool's cam and the upper edge of the light ring is lying flat in the holder of the tool. The numbers should be positioned toward the end of the tool. Press the cheeks of the tool to grasp the light ring (Fig. 39a).
- Two guide hooks are located on the underside of the light rings. These must fit into the two grooves of the opening. Insert the light ring (holding the condenser tool angled slightly upward and at a 90° angle to the housing) so that the mount fits under the spring clip of the retainer (Fig. 3).



Caution:

Do not press the spring clip down under any circumstances. This can destroy the clip or result in an unstable position of the light ring.

Turn the light ring to ensure that it snaps into position and release the tool.

Remove fingerprints or dust from the prism with care.

- Use the left centering screw to roughly center the light ring. The right centering screw must **not** restrict the range of adjustment under any circumstances.
- Note the number of the opening and the light ring designation for entry into the Leica Application Suite (LAS).
- Remove the adjusting key and close the condenser.
- Fine adjust with the Bertrand lens or telescope after switching the unit on (Fig. 32).

Please continue reading if you also have to install IC prisms. Otherwise, skip to the next section.

Fig. 36 Phase rings



Fig. 37 Condenser prisms



Installation of IC Prisms

- Switch the microscope off.
- Remove the condenser cover (38.1). Insert the prism in one of the condenser disk's large receptacles with guide grooves.
- Turn the right-hand centering screw back fully with the adjusting key (39.2). To prevent the condenser disk from turning further, insert the adjusting key (39.2) into the left-hand centering screw of the disk. It may protrude a **maximum of 1 mm** into the opening.
- Grasp the prism to be installed with the condenser tool (the lettering must face upward and be legible) so that the tab of the prism ring is positioned to the center of the tool's cam, and the upper edge of the prism is lying flat in

the holder of the tool. The numbers K2 to K16 should be positioned toward the end of the tool. Press the cheeks of the tool to grasp the prism (Fig. 39a).

- Two guide hooks are located on the underside of the prisms. These must fit into the two grooves of the opening. Insert the prism (holding the condenser tool angled slightly upward and at a 90° angle to the housing) so that the mount fits under the spring clip of the retainer (Fig. 39a).

Fig. 38 Condenser

- 1 Condenser cover
- 2 Centering opening

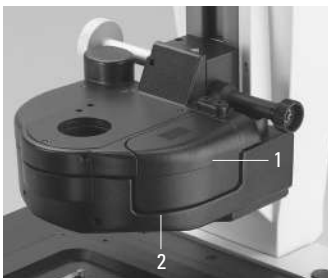

Fig. 39 Open condenser

- 1 Condenser tool
- 2 Adjusting key

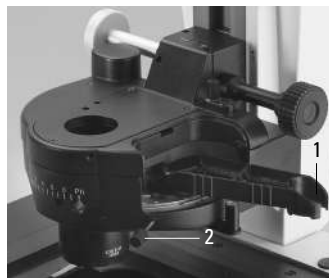

Fig. 39a Inserting the prism

The designation must be visible when installed and oriented toward the center of the condenser.

DIC images are not possible otherwise.





Caution:

Do not press the spring clip down under any circumstances. This can destroy the clip or result in an unstable position of the prism.

Turn the prism to ensure that it snaps into position and release the tool.

Remove fingerprints or dust from the prism with care.

- Use the left centering screw to roughly center the prism. The right centering screw must **not** restrict the range of adjustment under any circumstances.
- Note the number of the opening and the prism designation for entry into the Leica Application Suite (LAS).
- Remove the adjusting key and close the condenser.
- Fine adjust with the Bertrand lens or telescope after switching the unit on (Fig. 32).

Installation of Condensers

The installation procedure is identical for all condensers S1 to S70 (motorized or manual/coded - not coded for S40).

Release the socket head screw at the right side of the condenser holder. Place the condenser on the retaining pins of the illumination arm and move the condenser to the correct height. Use the markings on the column and condenser to determine the correct position.

Once you have reached the correct position, tighten the socket head screw.

Fig. 40 Installation of condenser on transmitted light illumination arm



Condenser Heads

Four different condenser heads are available:

- 1) S1/1.40 oil
- 2) S1/0.90 dry
- 3) S23/0.53
- 4) S28/0.55

Condenser heads 3 and 4 are screwed directly into the condenser body. A spacer ring (42.2) must be screwed into the thread at the bottom of the condenser body prior to installing condenser heads 1 and 2. The S1 condenser heads fit into this ring.

The S40 and S70 condensers are delivered complete with a condenser head, making additional assembly unnecessary.

Fig. 42 Installation of condenser heads S1

- 1 Condenser base
- 2 Spacer ring
- 3 Condenser head

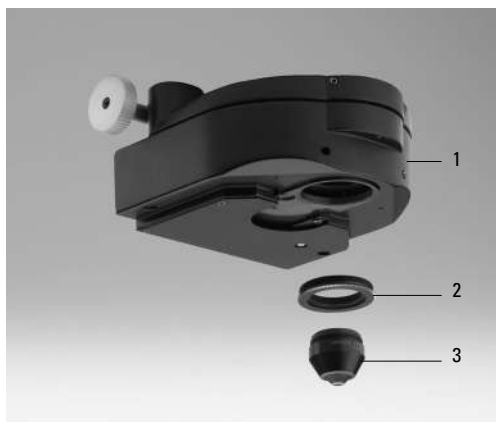

Fig. 41 Condenser on transmitted light illumination arm

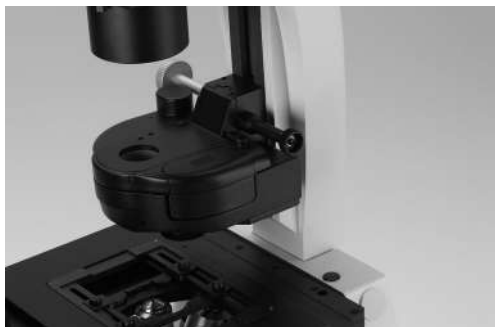

Fig. 43 Installation of condenser head S28



6.6 Installation of Eyepieces

The eyepieces are inserted into the eyepiece tubes.



Note:

We recommend running a teach-in via the Leica Application Suite (LAS) software when using eyepieces not included in the scope of delivery. This will ensure that the total magnification shown on the LeicaScreen is correct.

Fig. 44 Eyepieces



Fig. 45a Objective turret



6.7 Installation of Objectives

The positions in the objective turret disk are numbered (Fig. 45). Depending on your equipment, the individual objectives have already been assigned to specific positions at the factory.

For details on the exact positions of the objectives, please refer to the enclosed identification sheet.



Caution:

Close vacant threads in the nosepiece with dust protection caps!

Please note that the front lenses of the objectives point upward and are therefore more vulnerable to contamination than those of upright microscopes.

Check the front lenses for cleanliness frequently.



Note:

Leica DMI6000 B:

We recommend running a parfocality compensation via the Leica Application Suite (LAS) software.

Fig. 45b Objective turret, loaded

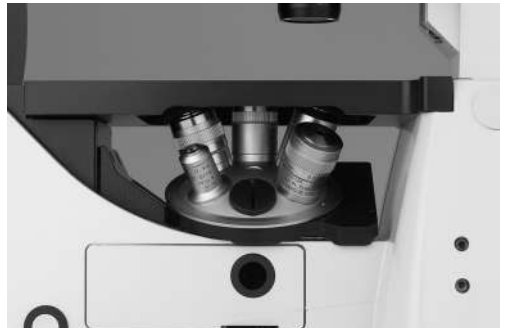

6.8 Installation of Filters in the Illumination Arm

The Leica DMI Series is equipped with a filter magazine to accommodate two 40 mm dia. filters as a standard feature. The filters are factory-installed. To change filters yourself, proceed as follows:

- Release the screw (46.1) and remove the cover.
- Place the filter in the holder.
- Place the cover on transmitted light illumination carrier and fasten with the locking screw.

Leica DMI6000 B:

- Activate the filters via the Leica Application Suite (LAS/LAS AF).

Leica DMI3000 B and Leica DMI4000 B:

- Mark the 2 levers with the provided adhesive labels.

Fig. 46 Unscrewing the filter holder cover and inserting filters in the transmitted light illumination arm

1 Screw

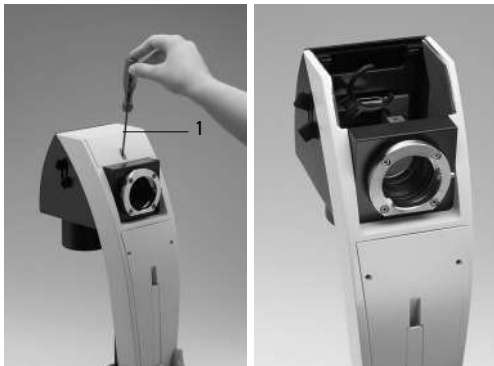
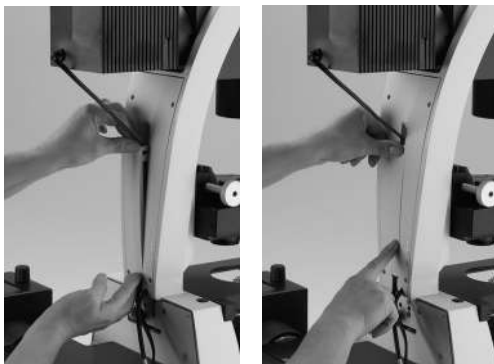

Fig. 48 Lamp housing cabling (cable duct)



6.9 Installing the transmitted Light Lamp Housing

- Place the lamp housing in the transmitted light lamp housing mount (Fig. 47), and fasten it with the clamping screw on the side.
- Thread the cable through the transmitted light illumination arm (Fig. 48).
- Connect the lamp housing cable to the power supply for transmitted light on the Leica CTR4000–7000 electronics box (Fig. 49.1).

Leica DMI3000 B:

- For the DMI3000 B, connect the cable directly to the back of the microscope.

For instructions on changing the lamp, please see Chapter 6.10.

These instructions also apply to installing an Hg lamp on the transmitted light axis. For descriptions of the lamp housings and replacement of the burner, please see Chapter 6.12, → p. 49ff.

Fig. 47 Mounting the lamp housing on the transmitted light illumination arm



Fig. 49 Connecting the lamp housing to the Leica electronics box, example: Leica CTR6000

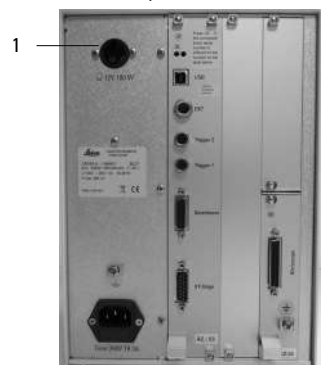

6. Assembly

6.10 Installation and Replacement of the transmitted Light Lamps: 107 or 107/2 Lamp Housing

This lamp housing is used with a 12V 100W Halogen Lamp, which is already mounted.
In case the lamp has to be removed:

Changing the 12 V 100 W halogen lamp



Caution!

Ensure that the lamp housing has been disconnected from the power supply. Unplug the power plug and the power supply during assembly.



Caution!

Light sources pose a potential irradiation risk (glare, UV-radiation, IR-radiation). Therefore, lamps have to be operated in closed housings and only after being mounted.

Fig. 50a

Lamp housing 107/2
Releasing the
fastening screw

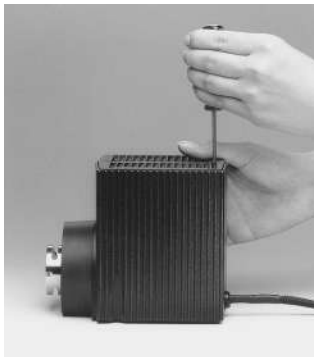

- Remove the fastener screw on the housing (Fig. 50a).



Caution!

The lamp and the lamp housing may still be hot.

- Lift the housing off (Fig. 50b).
- Remove the lamp.



Caution!

Do not remove the new lamp's dust cover until you have installed the lamp. Avoid fingerprints on the lamp.

Fig. 50b

Removing housing

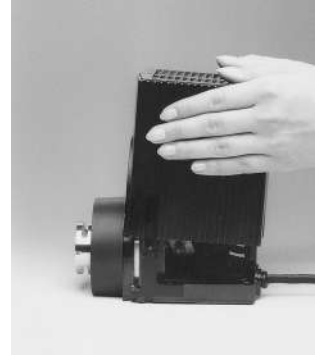

Fig. 50c

Lamp housing 107/2
opened

- 1 Mount with halogen lamp
- 2 Collector

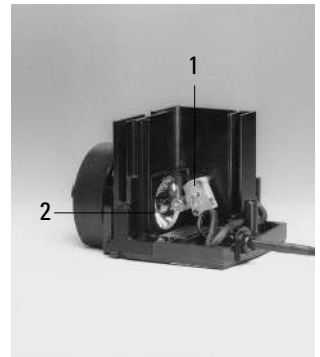
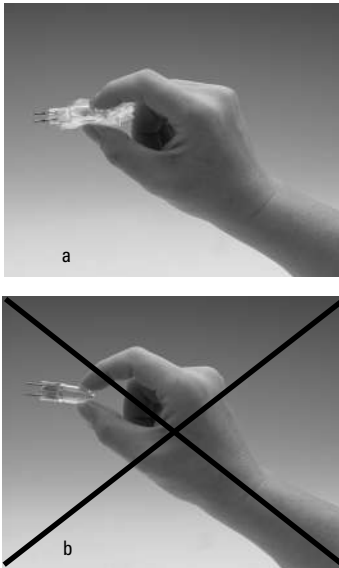

Fig. 51
Inserting
lamp with
cover
a right
b wrong



- Insert the new 12 V 100 W lamp (Fig. 51) with the dust cover straight into the socket until it stops. Be sure that the lamp is inserted straight.
- Remove the lamp's dust cover.

Fig. 52 Rear view, Leica DMI4000 B and DMI6000 B

- 1 Installation point for lamp housing mount or mirror housing
- 2 Holes for lamp housing mount or mirror housing screws

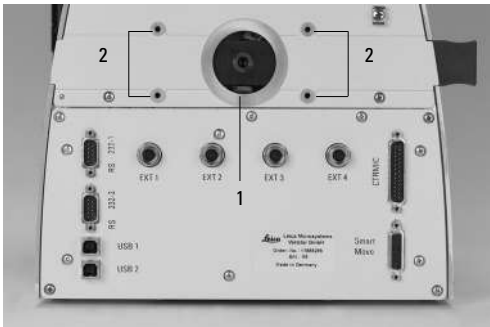

- Replace the housing and fasten it in place using the fastening screw.

6.11 Installing the Lamp Housing Mount and Mirror Housing (Leica DMI4000 B and DMI6000 B)

Place lamp housing mount (Fig. 53) or mirror housing on rear wall. Mount from front with socket head screws.

Fig. 53 Lamp housing mount



Fig. 54 Lamp housing 106z

- 1 Collector adjustment
- 2 Vertical lamp adjustment
- 3 Horizontal lamp adjustment
- 4 Adapter ring

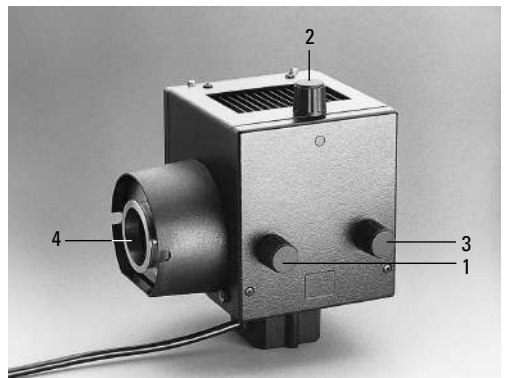

6. Assembly

Next, attach the appropriate connector(s) (right, left, straight) to the lamp housing mount. The lamp housing or coupling is then mounted on the connector, which is also held by four screws. If a booster lens is included in the scope of delivery, insert it into the rear stand opening at the left or right, depending on the stand model.

The booster slide has several positions:



1. Slide pulled out:
no effect
2. Depending on orientation of slide:
 - a) symbol  visible:
center orientation
The intensity of the fluorescence is increased by 50% in the center of the field of view (approx. 30% of the field).
 - b) symbol  visible:
The overall intensity is reduced by 25%. The entire field of view is evenly illuminated, however.

Fig. 56 Booster lens in stand
1 Booster lens

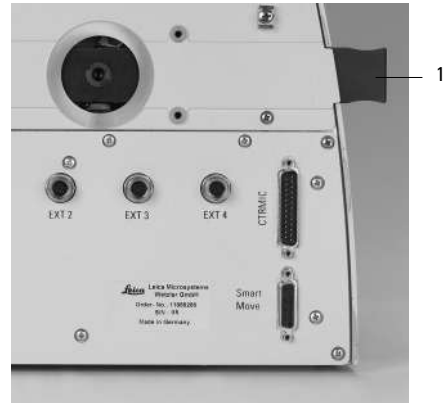
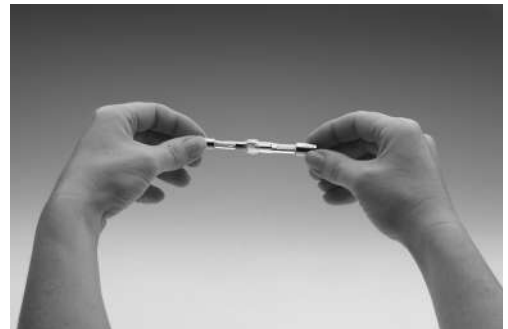

Fig. 55 Booster lens



Fig. 57 Hg-mercury burner



6.12 Installation and Replacement of Incident Light Lamps



Caution!

Light sources pose a potential irradiation risk (glare, UV-radiation, IR-radiation). Therefore, lamps have to be operated in closed housings and only after being mounted.

Ensure that the lamp housing has been disconnected from the power supply. Unplug the power plug and the power supply during assembly.

During assembly work on xenon burners, always wear the supplied protective gloves and face protection (Fig. 58) (risk of explosion).

Never touch the glass parts of the burner with bare hands.
Never look directly into the beam path (blinding hazard).

Fig. 58
Protective gloves and mask



Lamp Housing 106 z

This lamp housing is suitable for use with a 12 V 100 W halogen lamp or a variety of gas discharge lamps.



Caution!

Make sure to follow the instructions and safety notes of the lamp supplier.
Before changing lamps allow at least 30 minutes for cooling down!



Caution!

The lamp may still be hot.

Fig. 59 Lamp housing 106 z L with Hg 100 W lamp

- 1 Collector focusing
- 2 Vertical lamp adjustment
- 3 Horizontal lamp adjustment
- 4 Hg lamp mount
- 5 Reflector adjustment (not visible)

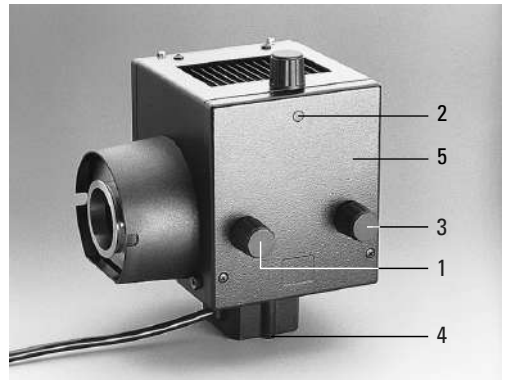

6. Assembly

Inserting Gas Discharge Lamps (Hg and Xe) in the 106z Lamp Housing

Hg and Xe lamps are powered by separate supply units.

Please also read the separate instruction manual provided with these supply units.

The following gas discharge lamps may be used and require different supply units and lamp mounts (Fig. 60, 61):

Type	Typical Bulb Life ⁺⁾
100W high-pressure mercury burner (direct current)	200 hrs.
100W high-pressure mercury burner, type 103 W/2 (direct current)	300 hrs.
75W high-pressure xenon burner (direct current)	400 hrs.

+) Please observe the data sheets of the lamp manufacturer.

Fig. 60 Lamp mounts for Hg 100 gas discharge lamp

- 1 Upper clamping system
- 2 Lower clamping system
- 3 Cooling element

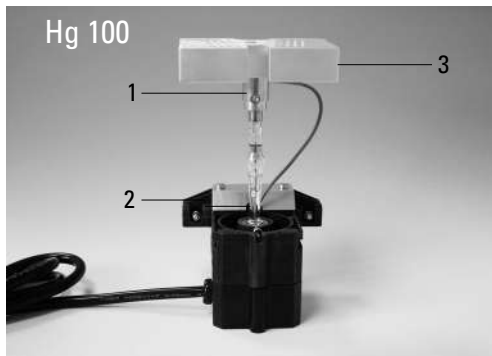
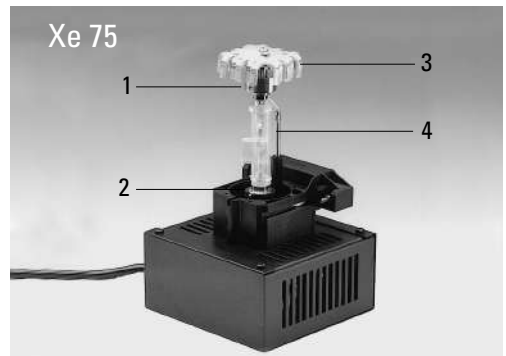

Fig. 61 Lamp mounts for gas discharge lamp Xe 75

- 1 Upper clamping system
- 2 Lower clamping system
- 3 Cooling element
- 4 Protective cover of Xe 75 burner



**Caution!**

Make sure to follow the safety notes on page 49.

- To open the 106 z lamp housing, unscrew the fastening screws on the cover I. Loosen the contact plug somewhat and pull it out of the socket (63.9). Flip the cover up (63.1).
- Loosen the mounting screws (63.8) on the lamp socket and pull the socket out.
- Remove the transport anchorage (red plastic rod in place of the burner) in the lamp mount. To do so, remove the lower clamp (60.1, 61.1). Pull up the cooling element (61.3, 60.3) and turn it to the side. Detach the lower clamp system (61.2, 60.2) and remove the transport anchorage.

Fig. 62 Rear panel of ebq 100 supply unit

1 Lamp connection

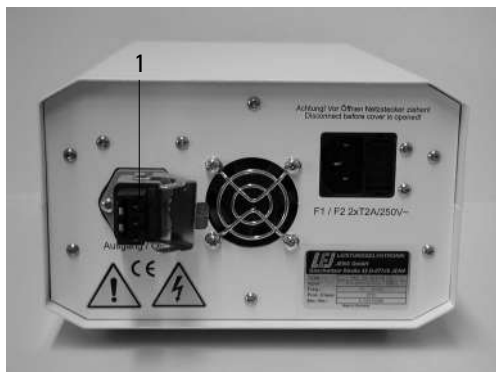
**Caution!**

Do not remove the burner's dust cover until you have installed the lamp. Avoid fingerprints on the lamp. Sweat from your fingers on the glass will shorten the life of the lamp significantly.

- Install the burner in reverse order.

**Caution!****Xe 75 burner:**

Remove the burner's dust cover (61.4) after you have installed the burner.

Fig. 63 106 z lamp housing (on the side, open)

- 1 Cover raised
- 2 Collector
- 3 12V 100W lamp or gas discharge lamp in mount
- 4 Reflector (mirror)
- 5, 6, 7 Adjusting screw for x-y reflector
- 8 Locking screws for lamp mount
- 9 Socket for contact plug

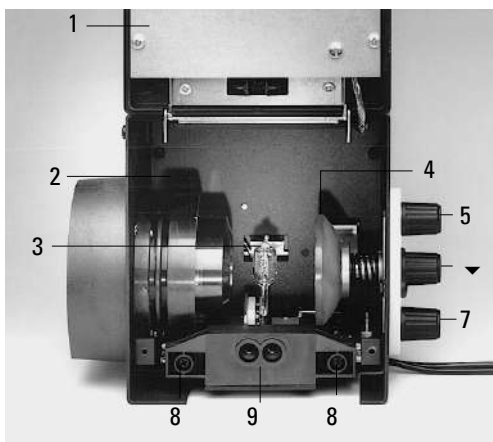

6. Assembly

- Insert the lamp mount, with the burner installed, into the lamp housing and tighten it with the screws (63.8).
- Test the adjustment of the collector (63.2):
Do not touch the power supply while performing these actions. When closing the lamp housing, ensure that the pins of the contact plug engage in their sockets (63.9).
Tighten the screws of the cover and press the contact plug home.
- Place the lamp housing in the incident light lamp housing mount (Fig. 53) and fasten it with the clamping screw on the side.
- Connect the lamp housing to the external power supply (62.1).

Leica EL6000



Caution!

When using the compact light source Leica EL6000, it is essential to observe the safety information in the separate instructions.



Caution!

The burner must be adjusted immediately after lighting.

6.13 Equipping the Incident Light Turret Disk

! Caution:

Please read this section completely before beginning with the assembly of the turret disk.

Leica DMI4000 B and Leica DMI6000 B:

The fluorescence drawer is located on the right side of the stand. Before opening this drawer, remove the cap below the drawer covering the analyzer slot (65.1). Remove the analyzer if it is already in the slot.

The replacement of individual cubes is more convenient with the microscope switched on. The position to be changed then automatically turns to the outside and you can be sure that the cube is positioned in the correct holder. You can therefore postpone installing the filter cubes until after the microscope has been switched on.

You can also insert the filter cubes while the instrument is switched off.

Press the white button next to the drawer. The drawer will glide out into its initial position.

Fig. 64a Filter cube, front side



Fig. 64b Filter cube, back side



Fig. 65 Opening the fluorescence drawer
1 Analyzer slot

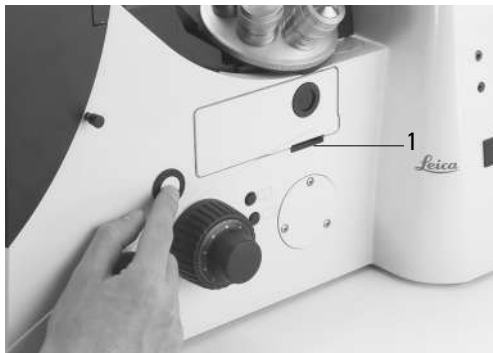

Fig. 66 Open fluorescence drawer
1 Lever for fixing the loading position



Fig. 67 Inserting or removing a filter cube



6. Assembly

The positions in the turret disk are numbered. Depending on your equipment, the individual filter and reflector cubes have already been assigned to specific positions at the factory. For details, check the identification sheet included with your order.

Now open the drawer several mm further until it clicks into its end position. Actuate the lever (66.1) to engage the turret disk in the loading position.

You can now insert a filter block. Proceed as follows:

- With the holder facing you squarely, insert the filter or reflector cubes into the holder in accordance with the included identification sheet.
- The fluorescence cubes are suitable for both upright and inverted microscopes. When using them with inverted microscopes, insert them so that the writing is upside down along the lower edge.

To do so, place the filter or reflector cube on the **left** side and press it to the **right** into the mounting (Fig. 67).

- Ensure that the cube is correctly seated. A loose cube can block the disk or be destroyed by the turning disk.

- Release the lever (66.1) again to turn the disk on to the next loading position. Continue in this way for all of the cubes.
- Once all filter and reflector cubes have been inserted, close the drawer and replace the analyzer or cap.

Replacing Cubes with the Instrument Switched On:

- Remove the analyzer or the cap of the analyzer slot.
- Press and hold the **Shutter** button on the front panel and press the button of the cube you would like to insert or replace at the same time.
- The filter changer will then rotate to the correct position to insert or replace the cube when you open the drawer by pressing the white button on the right side of the stand. The following message will appear in the top line of the LeicaScreen.

Load!

To insert the cubes, proceed exactly as described above.

Leica DMI3000 B:

To equip the turret disk with filter cubes, the turret disk must be removed from the stand (left side of stand, Fig. 68).

The supports of the disk are labeled Pos1 to Pos5 (Fig. 69).

- Pull the filter slider out of the stand.
- Insert the filter cubes in the supports so that the labeling is upside down.
To do this, position the filter cube at the **left** side and engage it to the **right** in the mount.
One position of the turret disk must remain free for transmitted light bright field.
- When all filter cubes are inserted, push the filter slider to the stop again in the left stand side.

Fig. 68 Removing the filter slider



Fig. 69 Filter slider



6.14 Inserting the Front Module Slider

If your microscope is prepared for integrated modulation contrast or integrated phase contrast, a front module (possibly in conjunction with a manual magnification changer) will be integrated in the stand. This is recognizable by a 2 x 3 cm opening at the left front side of the microscope. If this opening is not present or closed, then your microscope is not prepared for the integrated processes.

A slider for integrated modulation contrast or integrated phase contrast fits in this opening. The phase contrast slider may still require the installation of phase rings.

Insert the slider with the markings facing forward. It features a bright field position and two positions for contrast methods (position A and position C).

(A and C designate the eyepoint of the used objective. Please refer to the included objective list for the eyepoint of your objective. It can also be found engraved on the objective.)

Fig. 70 Mechanical polarizer holder

- 1 Manual polarizer
- 2 Manual analyzer



6.15 Installation of the Polarizer and Analyzer

Installed at the factory.

To change the components, proceed as follows:

Motorized condenser:

See included installation instructions.

Manual condenser:

Attach the single or triple position holder to the top of the manual condenser. The holder has a guide that must be inserted in the opening next to the screw threads. The holder must be positioned so that the polarizer or filter to be used covers the opening of the condenser.

Insert the polarizer or filter with the correct side facing up into the holder (λ : lambda and polarizer; POL: polarizer only). A click mechanism will indicate proper seating. The polarizer must turn easily between the two stops (approx. 30°).

Fig. 71 Condenser with motorized polarizer



Analyzer for Incident Light and Transmitted Light.

- Remove the cap (Fig. 72) on the right side of the stand (under the fluorescence drawer).
- Insert the analyzer into the receptacle until it latches in place (Fig. 73.1).

Fig. 72 Analyzer slot cap**Fig. 73** Inserting the analyzer

- 1 Slot
- 2 Analyzer

**Fig. 74** Inserting the analyzer

6.16 Optional Accessories

Camera

Connecting a camera

A camera can be installed using a C-mount or Vario mount.

- Place the C-mount or Vario mount onto one of the camera ports and secure it with the locking screw at the side.
- Screw on the camera.



Note:

When using a C-mount or Vario mount, run a teach-in via the Leica Application Suite (LAS) software.

Connecting multiple cameras

Two or more cameras – for example a digital and an analog camera – can be adapted as required.

- When using a DC type camera, connect the camera to the PCI card of your PC.
- When using a DFC type camera, connect the camera to the FireWire card of your PC.



Note:

Please read the separate operating manual of your digital camera.

Fig. 75 C-mount 0.63x



Fig. 76 C-mount 0.5x



6.17 Connection to the Electronics Box CTR4000, CTR5000, CTR5500, CTR6000, CTR6500, CTR7000, CTR6500 HS, CTR7000 HS

The Leica DMI 3000 B is supplied without an electronics box. The power supply is integrated in the stand and a socket has been provided on the back of the microscope to connect the transmitted light illumination. The illuminated ON/OFF switch is located on the stand.

Fig. 77 Rear view of electronics box, example: CTR6000

- 1 Mains socket
- 2 Earth screw
- 3 Type label
- 4 Port **12V 100W**
for the lamp cable of the microscope
- 5 **DL**: reset-button
- 6 Port **USB** for communication with PC
- 7 Port **Ext**, IC interface
for additional external components
- 8 Port **Trigger 2** for external synchronisation
- 9 Port **Trigger 1** for external synchronisation
- 10 Port **SmartMove**
for Leica SmartMove control device
- 11 Port **Microscope**
for communication with the microscope
- 12 Port **XY-Stage** for motorized stage
- 13 Equipotential bonding symbol
- 14 Equipotential bonding

CTR 4000 Electronics Box

The Leica DMI 4000 B is supplied with the CTR4000 electronics box. The power supply for the microscope is located in this box. Two sockets are located on the back of the CTR4000 electronics box for 12V/100W transmitted light and 12V/100W incident light illuminators. The illuminated ON/OFF switch for the microscope is located on the CTR4000 electronics box.

Fig. 78 Rear view of stand

- 1 RS232 ports
- 2 2 x USB
- 3 4 x EXT.
- 4 Connection for SmartMove
- 5 Electronic box connection
- 6 Condenser cable
- 7 Lamp power cable

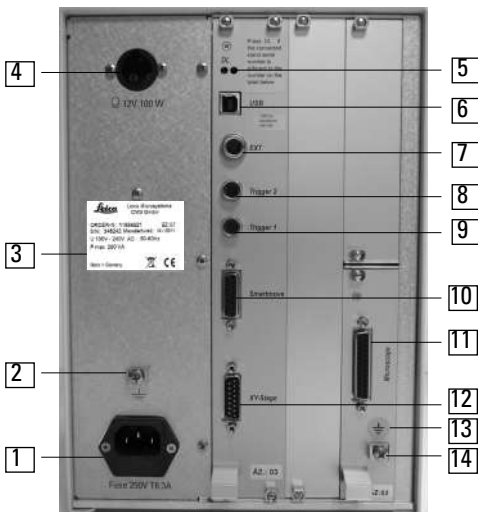
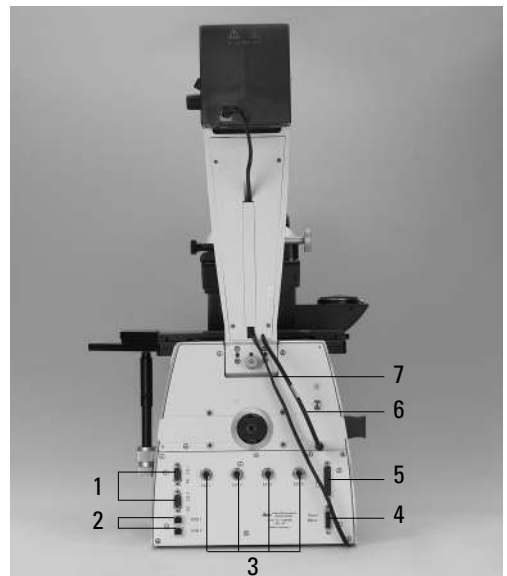

6. Assembly

CTR4000, CTR5000, CTR5500, CTR6000, CTR6500, CTR7000, CTR6500 HS, CTR7000 HS Electronics Box:



Note:

These electronics boxes must not be used with other stands. The serial number of the associated stand has been recorded on the back of the electronics box.

A 3-axis control unit for focus and motor stages is integrated in the CTR6000.

A 3-axis control unit for focus and a scanning stage is integrated in the CTR6500/7000.

- Connect the **Microscope** (77.11) socket to the back of the stand (78.5) using the 25-pin microscope cable.
- Connect the SmartMove remote control module to the **SmartMove** socket (77.10).
- Connect the motorized stage, if present, to the **XY-Stage** socket (77.12).
- Connect the lamp power cable (78.7) to the **12 V, max 100 W** socket (77.4).

Fig. 79 Rear panel of ebq 100 supply unit
1 AC power supply socket

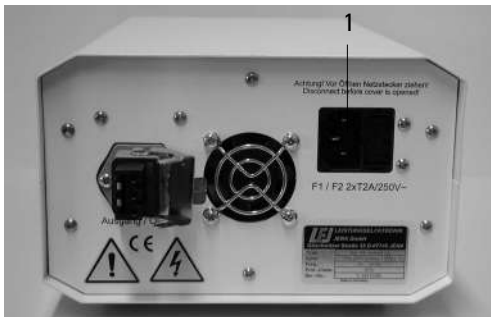

Caution!

Ensure that the plugs are correctly inserted and secured to prevent overheating of the sockets.

6.18 Connection to the Computer



Note:

To start the Leica Application Suite (LAS/LAS AF), ensure that the COM1 serial port is not in use by another program or driver. This is frequently the case when using Palms or other PDAs or when using external modems or other devices. The devices in question must therefore **always** be disabled before using the Leica Application Suite (LAS/LAS AF) software.

- Please use the included serial cable. Connect the COM1 port of your PC with the RS232C port (78.1) on the back of the stand. Alternatively the PC can be connected via USB.

6.19 Connection to the Power Supply

- Once all installation work is complete, connect the electronics box to an AC power outlet with the included power cable (socket 77.1).
- If you are using the external ebq 100 supply unit or the compact light source Leica EL6000, connect it to an AC power outlet at this time (socket 79.1).

7. Start-up

7.1 Functional Principle (Leica DMI4000 B and Leica DMI6000 B)

Thanks to its intelligent automation, the Leica DMI4000 B and DMI6000 B can be controlled using a variety of control elements.

1. Intelligent Automation

- Switching between contrast methods at the touch of a button. Light rings, DIC prisms, etc. are automatically positioned in the beam path.
- The microscope recognizes the selected objective and associated contrast method. The intensity (INT), aperture diaphragm (AP) and field diaphragm (FD) are always set to suitable values.
- The INT, AP and FD values are always based on the currently activated illumination axis (transmitted light or incident light).
- The INT, AP, and FD values can be adjusted individually. Manual adjustments overwrite the previous settings. The current setting is stored and is retained from one session to the next when power is switched off.

2. Controls

- SmartMove knobs
for stage and focus control
- Fixed function buttons on stand
for INT, AP, and FD, as well as for switching between transmitted light and incident light axis
- Variable function buttons on stand, SmartMove, STP6000
These function buttons have functions suitable to the configuration of your microscope assigned to them at the factory. The functions can be reprogrammed and/or adapted to your specific requirements, however.
- Complete control of microscope and camera via software
(Leica Application Suite (LAS/LAS AF))



Note: (reset function)

The microscope can be reset to its factory default programming:

- With the stand switched off, press the top three variable function buttons on the left side of the stand.
- Switch on the power for the stand.
- Hold the buttons until the initialization is complete.
- The standard information display will now appear on the LeicaDisplay.
- Switch the instrument off and back on. The settings are now saved.

The table on the following page provides an overview of the microscope functions and their controls.

Function (DMI4000 B and DMI6000 B)	Fixed Function buttons Stand		Variable Function buttons Stand		SmartMove				Software and STP6000
	4000	6000	4000	6000	Function buttons		Rotary knobs		
					4000	6000	4000	6000	
Select contrast method	-	-	+	+	+	+	-	-	+
Change transmitted light/incident light axis	+	+	-	-	-	-	-	-	+
Change to objective	-	-	-	+	-	+	-	-	+
Teach-in parfocality	-	-	-	-	-	-	-	-	+
Change operating mode (dry/imm)	-	-	+	+	+	+	-	-	+
Illumination Manager	+	+	+	+	+	+	-	-	+
Magnification changer (motorized)	+	+	-	-	-	-	-	-	+
Focusing	-	+	-	-	-	-	-	+ ¹⁾	+
Set stops	-	+	-	-	-	-	-	-	+
Go to stop	-	+	-	-	-	-	-	-	+
Change step increment (coarse/fine)	-	-	-	+	-	+	-	-	+
XY stage positioning	-	-	-	-	-	-	+	+	-
Change speed	-	-	-	-	-	-	-	-	+
Stage positions (store/go to)	-	-	-	-	-	-	-	-	+
Change to filter/reflector cube	+	-	+	(+)	+	+	-	-	+
Side and bottom port (DMI6000 B only)	+	-	(+)	-	+	-	-	+	+
DIC fine adjustment	+	+	-	-	-	-	-	-	+
Adaptive Focus Control (AFC)	-	+	-	+	-	+	-	-	+

+ always possible

(+) optional

- not possible

¹⁾ Focusing alternatively via wheels

Possible Assignments for Variable Function Buttons on Stand and SmartMove For Leica DMI4000 B and Leica DMI6000 B:

Function button	Function
BF	Bright field transmitted light
PH	Phase contrast transmitted light
ICT	Interference contrast, transmitted light
DF	Dark field transmitted light
IMC	Integrated modulation contrast
POL	Polarization transmitted light
CHANGE TL ●	Cycle through all contrast methods
INT ↑	Increase intensity (transmitted light)
INT ↓	Reduce intensity (transmitted light)
AP ↑	Open aperture diaphragm (transmitted light)
AP ↓	Close aperture diaphragm (transmitted light)
FD ↑	Open field diaphragm (transmitted light)
FD ↓	Close field diaphragm (transmitted light)
SHUTTER TL	Open/close TL shutter
TL FLT 1	Enable/disable transmitted light filter at position 1
TL FLT 2	Enable/disable transmitted light filter at position 2
FLUO	Fluorescence (last filter cube)
CUBE 1-6	Select filter cube in position 1-6
CHANGE CUBE CW	Change cube clockwise (1 → 4)
CHANGE CUBE CCW	Change cube counterclockwise (4 → 1)
INT FLUO ↑	Increase intensity (fluorescence)
INT FLUO ↓	Reduce intensity (fluorescence)
FD FLUO ↑	Open field diaphragm (fluorescence)
FD FLUO ↓	Close field diaphragm (fluorescence)
CHG FW	Toggle filter functions
IFW	Activate external filter wheel
ExMan	Activate Excitation Manager
SHUTTER FL	Open/close fluoshutter
COMBI ●	Combination method (PH fluorescence or ICT fluorescence)
CHANGE COMBI ●	Cycle through all combination methods
CHANGE OBJ CW	Cycle through objectives clockwise
CHANGE OBJ CCW	Cycle through objectives counterclockwise
Z FINE	Activate fine focusing (Leica DMI6000 B only)
Z COARSE	Activate coarse focusing (Leica DMI6000 B only)
XY PRECISE	Activate precise stage
XY FAST	Activate fast stage
BTP ON/OFF	Bottom port on/off (Leica DMI6000 B only)
DRY/IMM	Switch dry/immersion
CHANGE FLT	Switch TL filter
CHANGE CS	Switch to confocal application
OBJ 1-6	Select objective at position 1-6
MEM 1-6	Memory activated stored functions
AFC ON/OFF	Turns AFC on or off
AFC HOLD	Holds current position

7.2 Switching on the Microscope

Leica DMI3000 B:

- Switch on the microscope's power at the On/Off switch. The signal lamp is lit when the instrument is ready. (For the Leica DMI3000 B please continue at 7.4. Function Buttons on the Stand)

Leica DMI4000 B and Leica DMI6000 B:

- Switch on the power of the electronics box at the On/Off switch (80.1). The signal lamp (80.2) is lit green when the unit is ready. All motorized microscope components will then run through an initialization phase.



Note:

If a PC is connected, switch on **the electronics box first**, and **then the computer**.

After the initialization (Fig. 81) is complete, the LeicaScreen will display the microscope's current settings (Fig. 82).

Fig. 80 front side Leica CTR6000

- 1 On/Off switch
- 2 Signal lamp
- 3 Warning: Observe safety notes!

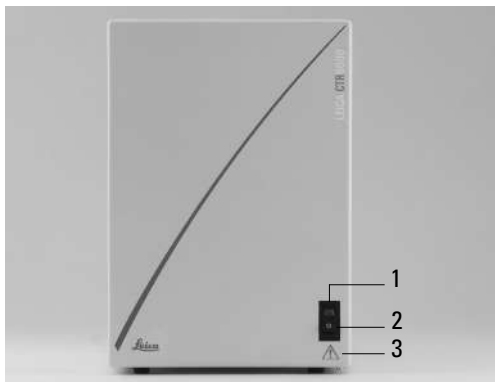

If a component has not been installed correctly, the LeicaScreen will display an error message. See Troubleshooting chapter, → p. 106.

Components such as diaphragms, condensers, light, and phase rings have been pre-centered at the factory. It may be necessary to correct the centering after the microscope has been transported and assembled.

Before performing the required steps, please familiarize yourself with the LeicaScreen and the controls.



Caution!

After turning on the gas discharge lamp, the burner must be immediately adjusted. Therefore, **do not** turn on the power supply unit yet. First, work in transmitted light in order to familiarize yourself with the microscope's controls.

Fig. 81
LeicaScreen
Initialization



Fig. 82
LeicaScreen
after
Initialization

	FLUO>DIC	
	40x Obj. IMM	
	1.5x MagCh.	Σ 600x
	INT 100% B G	-1 +2
	AP 33	FD 30
	80%	20%
	- 0.55 mm	coarse

7. Start-up

7.3 The LeicaDisplay (Leica DMI4000 B and DMI6000 B)

The screen displays the microscope's current settings. The content of the display depends on the features of the individual microscope. For information on the abbreviations used, please turn to the table of abbreviations → p. 114.

The screen has a number of areas and lines.

- Line 1: contrast method
- Line 2: objective/magnification
- Line 3: illumination/diaphragms
- Line 4: active ports
- Line 5: focus/stops (DMI6000 B only)

The content of the display changes according to the active function.

Pictograms





	Contrast method
	Objective/ Magnification
	Illumination Diaphragm
	Ports/Eyepiece
	Focus/stops (DMI6000 B only)

Fig. 83 Arrangement of the function buttons – overview

- 1 Four variable function buttons
- 2 Illumination Manager
- 3 Front control panel
- 4 Focus buttons (DMI6000 B only)
- 5 Three variable function buttons
- 6 SmartMove knobs
- 7 SmartMove function buttons



The motorized DMI stands can be controlled using the function buttons on the stand, the remote control SmartMove or the STP6000.

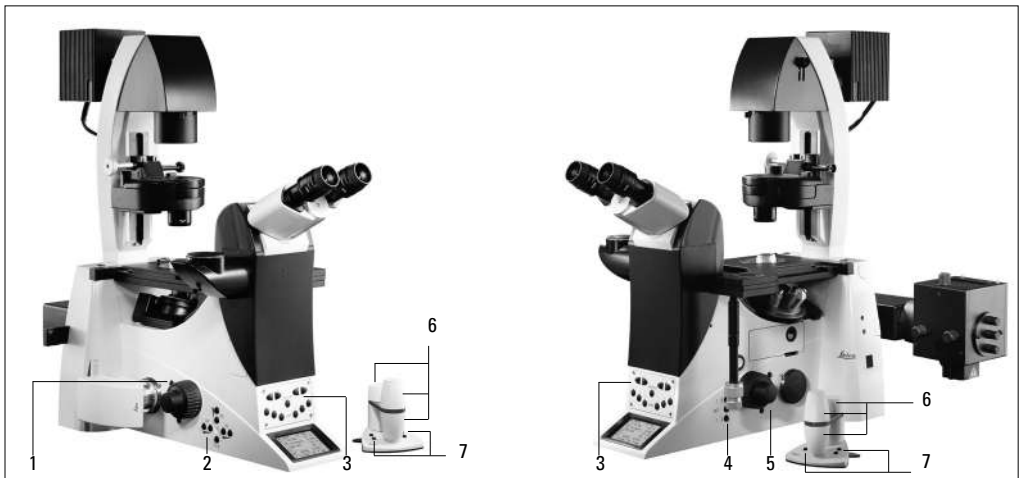

Note:

Changes to the light intensity as well as aperture and field diaphragm settings are stored for the individual objectives and contrast methods.

7.4 The Function Buttons on the Stand

Leica DMI3000 B:

- **Focus wheels:** the left-hand focus wheels can be used for both coarse and fine focusing; the right-hand focus wheel for fine focusing only (a version of the Leica DMI3000 B with mirrored focus controls is also available)
- **Light intensity:** the transmitted light intensity can be adjusted continuously from 0 to 12 V using the potentiometer at the lower left of the front of the microscope stand.

For the Leica DMI3000 B please continue at 7.6. Illumination.

Leica DMI4000 B and Leica DMI6000 B:

A number of function buttons are located on both sides of the stand. These can be broken down into fixed and variable buttons. The variable function buttons have different functions depending on the features of the individual microscope.

Fixed function Buttons on the Left Side

The **TL/IL** button (84.1) toggles between the incident-light and transmitted light axis. The contrast method last used with a given axis is restored when switching.

The **INT** buttons (84.3) adjust the light intensity. The adjustment can be made in coarse or fine steps. Pressing both **INT** buttons at the same time toggles between coarse and fine adjustment.

The **AP** buttons (84.2) for the aperture diaphragm and **FD** (84.4) for the field diaphragm open and close their respective diaphragms.

Fig. 84 Fixed function buttons (left side of stand)

- 1 Toggle transmitted light/incident light
- 2 Aperture diaphragm
- 3 light intensity
- 4 field diaphragm

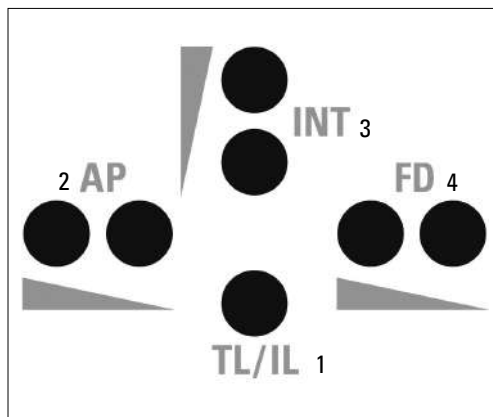

7. Start-up

Variable Function Buttons on the Stand

The variable function buttons are assigned functions at the factory that are appropriate to the features of your microscope. They are labeled accordingly. For details on button assignments, please refer to the included identification sheet. For information on the abbreviations used, please refer to the list → p. 64.



Note:

The Leica Application Suite (LAS) software is required for changing the button assignments.

Possible functions*:

BF	CHANGE CUBE CW
PH	CHANGE CUBE CCW
ICT	INT FLUO ↑
DF	INT FLUO ↓
IMC	FD FLUO ↑
POL	FD FLUO ↓
CHANGE TL ●	CHG FW
INT ↑	IFW
INT ↓	ExMan
AP ↑	COMBI ●
AP ↓	CHANGE COMBI ●
FD ↑	CHANGE OBJ CW (only DMI6000 B)
FD ↓	CHANGE OBJ CCW (only DMI6000 B)
SHUTTER TL	Z FINE (only DMI6000 B)
TL FLT 1	Z COARSE (only DMI6000 B)
TL FLT 2	XY PRECISE
FLUO	XY FAST
CUBE 1	BTP ON/OFF (only DMI6000 B)
CUBE 2	DRY/IMM
CUBE 3	CHANGE FLT
CUBE 4	CHANGE CS
CUBE 5	OBJ 1-6
CUBE 6	MEM 1-6
	AFC ON/OFF
	AFC HOLD

* See page 64 for abbreviations

Fig. 85 Function buttons (left side of stand)

- 1 Variable function buttons
- 2 Open/close aperture diaphragm
- 3 TL/IL switching
- 4 Open/close field diaphragm
- 5 Increase/decrease light intensity



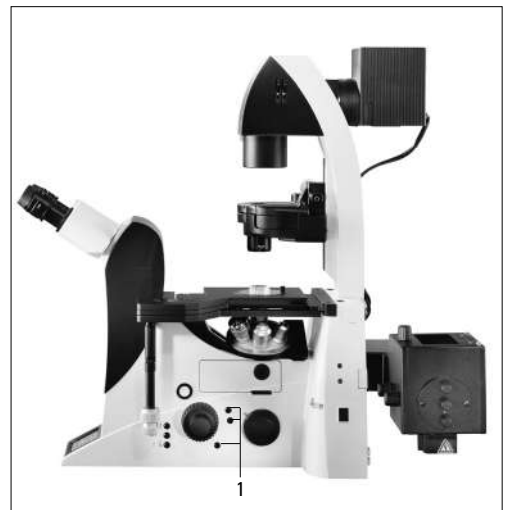

Fig. 86 Function buttons (right side of stand)

- 1 Variable function buttons



Function Buttons on the Front Panel (Fig. 87)

 100% of the light goes to the eyepiece (87.1).

 Toggle function for the side ports (87.2). This function depends on the individual microscope configuration.

Note:

Switching to the bottom port:
via the variable function buttons (Leica DMI6000 B only), switching to top port: manually.

SHUTTER Opens and closes the shutter (87.3).

 Switches between the possible magnifications of the magnification changer (87.4).

 The magnification changer is set to the magnification 1x (87.5).

CUBE The CUBE 1 to CUBE 6 (87.6) buttons permit the direct selection of individual filter cubes, provided the selected cube is valid for the selected method.

Press the CUBE 3 and CUBE 4 buttons at the same time to display the assignments of the variable function buttons. To reset the display, press the buttons again or wait 3 seconds.

Focus buttons (Fig. 88) (DMI6000 B only)

Z↑ Moves the Z drive in the indicated direction.
Z↓

SET + Z↑ Sets the upper focus stop.

SET + Z↓ Sets the lower stop.

Fig. 87 Front control panel

- 1 100% light to eyepiece
- 2 Toggle ports
- 3 Shutter
- 4 Switch between subsequent magnifications
- 5 Subsequent magnification 1x
- 6 Selecting filter cubes

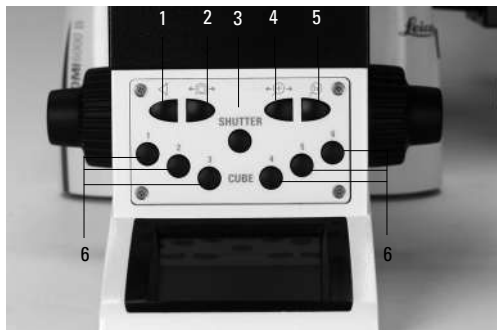
**Fig. 88**

- 1 Focus control buttons
- 2 Open filter drawer

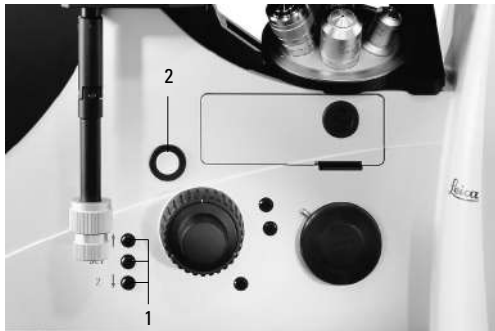

Shutter button + Cube buttons 1-6 (Leica DMI4000 B and Leica DMI6000 B only)

The selected cube is moved to the loading position for replacement. „Load“ appears on the screen. After pressing the button (88.2) the drawer is opened and the cube can be changed. The next filter cube will be moved to the loading position after the drawer is closed.

7.5 The SmartMove Remote Control Module

SmartMove knobs (Leica DMI4000 B and Leica DMI6000 B)

Use the knobs 89.1 and 89.2 to move the stage in X and Y directions.

The image is focused using the knob 89.3 (Leica DMI6000 B only).

The height of the knobs can be adjusted to a comfortable working position by turning 89.4.

Variable function buttons on SmartMove

The variable function buttons are assigned functions at the factory that are appropriate to the features of your microscope. They are labeled accordingly. For details on button assignments, please refer to the included identification sheet.

For information on the abbreviations used, please refer to the list → p. 64.



Note:

The Leica Application Suite (LAS) software is required for changing the button assignments.

7.6 Illumination

7.6.1 Transmitted light

If your microscope has not yet been set up for Koehler illumination, please continue with the „Koehler Illumination“ section.

Leica DMI3000 B:

- If necessary, adjust the TL bright field position at the filter slider.
- Select an objective with moderate magnification (10x–20x).
- Set the condenser to the bright field position.
- Place a specimen on the stage.
- Focus on the specimen using the focus wheels.
- Adjust the light intensity.
- Close the field diaphragm manually until the edge of the diaphragm appears in the field of view.

Fig. 89 SmartMove remote control module

- 1 Travel in x
- 2 Travel in y
- 3 Focus
- 4 Individual adjustment of button height
- 5 Variable function buttons (factory preset)

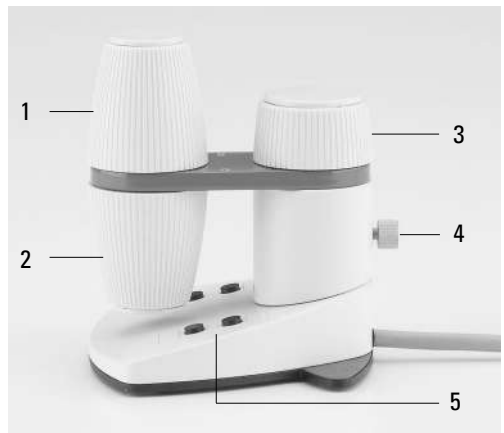

- Using the condenser height adjuster (90.2), adjust the condenser until the edge of the field diaphragm appears in sharp relief (not S40 and S70 condenser).
- Open the field diaphragm until it only just disappears from the field of view (91d).

Leica DMI4000 B and Leica DMI6000 B:

- Select an objective with moderate magnification (10x–20x).
- Activate the transmitted light axis with the **TL/IL** button (84.1).
- Press the **BF** button to activate the bright field contrast method (one of the variable function buttons on the stand).
- Place a specimen on the stage.
- Focus the specimen using the SmartMove or the focus wheels.
- Adjust the light intensity with the **INT** buttons (84.3).
- Close the field diaphragm with the **FD** button (84.4) or manually until the edge of the diaphragm appears in the field of view.
- Using the condenser height adjuster (90.2), adjust the condenser until the edge of the field diaphragm appears in sharp relief (not S70 condenser).
- Open the field diaphragm just enough for it to disappear from the field of view (91d).



Note:

The condenser height setting is dependent on the thickness of the specimen and may require adjustment for each new specimen.

Köhler illumination (not for S40 and S70 condenser)

Suitable values for the motorized aperture diaphragm and motorized field diaphragm have been preset for each objective (Leica DMI4000 B and Leica DMI6000 B). The condenser has also been centered at the factory.

However, it may be necessary to readjust the condenser in some cases. Therefore, check the condenser centering.

The following procedure is provided for the transmitted light-bright field illumination.

All required functions can be executed at the touch of a button with the Leica DMI6000 B electronic microscope. (See Chapter 8, Operation).

Preparation:

- Configure the microscope as follows:
 - Set up the illumination, condenser, objectives and eyepieces correctly. (Please ensure that the objectives are properly screwed in and check the eyepiece settings.)
- Switch the microscope on and wait for the initialization phase to complete (automatic functions only).
- You will need either an empty Petri dish (preferably with a glass bottom) with a marking in the middle or a stained specimen on a slide with a coverslip.

7. Start-up

- Switch to the 10x objective (if not present, the 20x objective).
- Ensure that the condenser is at the correct height. The condenser height adjustment lets you set the condenser head to the height of the nominal free working distance. (For an S23 condenser, for example, the distance between the surface of the stage and the front lens of the condenser is approx. 23 mm).
- Hold a piece of white paper (approx. 3-10 cm) under the light source (field diaphragm). A light ring should appear on the paper – if not, check the power cable, the light source and the fuse of the supply unit (CTR box) and ensure that all of the parts are correctly connected to one another.
- Open the field diaphragm as far as possible until the light ring reaches its maximum diameter.
- Next, hold the paper under the condenser, directly on the stage. Open the aperture diaphragm as far as possible, until the light ring has reached its maximum brightness. In order to achieve maximum brightness, ensure that no port is activated. The full light should be directed to the VIS port.
- Check the magnification changer to ensure that the 1x tube lens is selected.
- Adjust the lenses of the eyepieces so that one circle is visible in the eyepieces (not two!). If you wear spectacles, remove the antiglare hoods from the eyepiece tubes (or fold them back).
- Ensure that the focus on the eyepieces is set to ± 0 (turn the upper part of the eyepiece tubes until the silver ring is just covered).
- You should see light when looking through the eyepieces at this point.
If the light is too bright, reduce it as required.

Remove all unneeded components from the light path.

- Swing all filters (in the filter magazine of the lamp housing or the filter holder of the condenser) out of the beam path.
- Set the condenser disk to the bright field position.
- If your microscope is equipped for DIC:
 - Remove the polarizer.
 - Remove the analyzer.
 - Remove the objective prism (move the magazine to the „empty“ or „bright field“ position).
- If your microscope is equipped for fluorescence:
 - Select an empty filter position (or a filter with low transmission in the visible range, e.g. filter A).

Now to begin with the actual Koehler illumination:

- Place your specimen on the stage and focus so that you can see its details as clearly as possible. You probably will not get a perfect image at this point, as the illumination will not be optimal (90a).
- Next, attempt to get a **sharp image** (or at least a part of the image at the edge) by carefully moving the condenser up and down (90.2). Try this with a variety of field diaphragm settings until you get a clear, sharp image (91.b). This may take a while!
- To **center the sharp image**, insert the centering keys in the openings provided at either side of the top part of the condenser (90.1). Move the image into the center of the field of view (91.c). Next, open the field diaphragm until the image fills nearly the entire field of view. The black

edges of the image should have the same distance to the outer edge of the field of view on all sides. If not, recenter the image with the centering screws. Adjust the height of the condenser until the edges are sharp. Now open the field diaphragm until the image fills the entire field of view and the black edges have disappeared completely (91.d).

- The last step is the **adaptation of the contrast settings**. To improve the contrast, close the aperture diaphragm – if you close it too far, however, the resolution of the image details will deteriorate.

To see the aperture diaphragm, remove an eyepiece tube and look directly into the tube. Your eye should be around 10 to 20 cm from the tube. Change the size of the aperture diaphragm until its image is clearly visible in the pupil of the objective.

- Set the aperture diaphragm to cover 2/3 to 4/5 of the pupil diameter. You will now have the optimal balance between resolution and contrast.

Fig. 90 Condenser centering

- 1 Centering openings
- 2 Height adjuster
- 3 Prism and phase ring centering

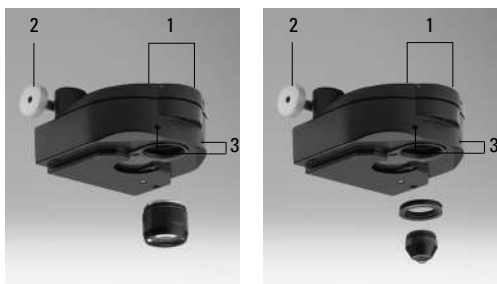

7.6.2 Incident Light - Fluorescence

Leica DMI3000 B:

- Select an objective with moderate magnification (10x–20x) and adjust the image.
- Close the field diaphragm with the turning knob until the edge of the diaphragm (round or angled) appears on the specimen level.
- If the limits of the field diaphragm are not in the center of the field of view, move the position of the field diaphragm to the center with the two centering screws on the right side of the stand using a 3 mm Allen key. When centering, observe the position of the field diaphragm through the eyepieces or on the monitor.
- Open the light field diaphragm until it just disappears from the field of view.

Fig. 91 Köhler Illumination

- a Field diaphragm not focused, not centered
- b Field diaphragm focused, but not centered
- c Field diaphragm focused and centered
Diameter is too small, however
- d Illumination field diameter = visible field diameter
(Köhler illumination)

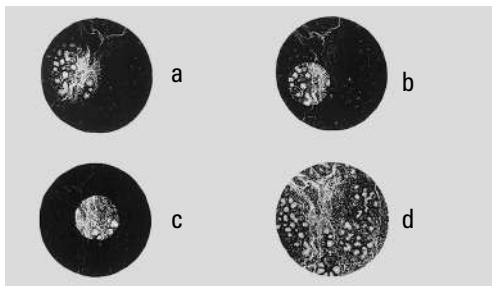

7. Start-up

Leica DMI4000 B and Leica DMI6000 B:

Suitable aperture and field diaphragm values have been preset for each objective. The incident light module has also been centered at the factory.

However, it may be necessary to readjust the incident light module in some cases after transporting and setting up the stand. Therefore, check the field diaphragm centering.

The following procedure is provided for the incident light-bright field illumination.

- Select an objective with moderate magnification (10x–20x).
- Activate the incident light axis with the **TL/IL** button (84.1).
- Press the **IL-BF / Fluo** button to activate the bright field contrast method (one of the variable function buttons on the stand).
- Place a specimen on the stage.
- Focus the specimen using the SmartMove or the focus wheels.
- Adjust the light intensity with the **INT** buttons (84.3).

Adjusting the field diaphragm*

- Close the field diaphragm with the **FD** button (84.4) or manually until the edge of the diaphragm (round or rectangular) appears in the field of view.
- If the limits of the field diaphragm are not in the center of the field of view, move the position of the field diaphragm to the center with the two centering screws (92.1) on the right side of the stand.
- Use the function buttons **FD** (84.4) to open the field diaphragm to the point that they just disappear from the field of view.

- We recommend the use of a rectangular field diaphragm when using a digital camera. Match the size of the diaphragm to the chip size of the camera.

7.7 Checking Phase Contrast Rings

If your microscope is equipped for phase contrast, light rings to match your objectives will be installed in the condenser.

The light rings are already centered in the factory. As a result of transport and setup of the stand, however, in some cases centering maybe be required again. Therefore check the centering.



Note:

Each objective has its own light ring assigned to it in the condenser. The test must therefore be performed for each objective.

Regular phase contrast with phase objectives

When choosing an objective suitable for phase contrast, the appropriate light ring is selected automatically when using a motorized condenser. Otherwise, select the light ring manually.

Fig. 92

Adjusting the field diaphragm (incident light-fluorescence)

- 1 Adjusting screws for moving the field diaphragm



* not in combination with structured illumination

Leica DMI3000 B:

- If necessary, adjust the TL bright field position at the filter slider.
- Set the condenser to the bright field position.

Leica DMI4000 B and Leica DMI6000 B:

- Press the **BF** (bright field) button (one of the variable function buttons on the stand).
- Instead of an eyepiece, place a focusing telescope (Fig. 93) in the observation tube or activate the Bertrand lens (pull rod (94.1) on tube).
- Select the phase contrast objective with the lowest magnification.
- Focus on the specimen.
- Focus the ring structure (95a) by loosening the clamping ring (93.2) somewhat and moving the eyelens (93.1), or focus the Bertrand lens (94.2).
- Retighten the clamping ring.

Fig. 93 Focusing telescope

- 1 Adjustable eyelens
- 2 Clamping ring for fixing the focus position

Leica DMI3000 B:

- Select the light ring for the active objective on the condenser.

Leica DMI4000 B and Leica DMI6000 B:

- Press the **PH** (phase contrast) button (one of the variable function buttons behind the focus wheels). The light ring will be selected in the condenser.

Fig. 94

- 1 Activating the Bertrand lens
- 2 Focusing the Bertrand lens

**Fig. 95** Phase contrast centering procedure

- PH=phase contrast ring, LR=light ring
- Condenser in bright field (BF) position
 - Condenser in phase contrast (PH) position
Light ring (LR) not centered
 - Light ring and phase ring centered

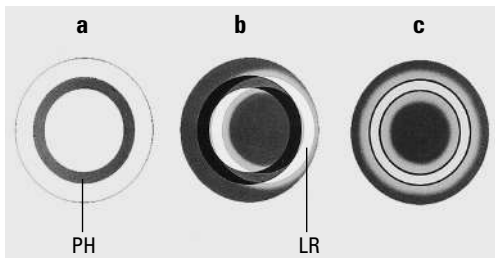

7. Start-up

- If the light ring and the phase ring are not shown as arranged in Fig. 95c, the light ring must be centered.
- Insert the centering keys into the openings provided on both sides of the condenser (90.3).
- Turn the centering keys until the dark ring (phase ring in the objective) is congruent with the slightly narrower bright ring (light ring in condenser) (95 c).



Caution!

The centering keys must be removed from the centering openings before changing objectives. They may block the condenser.

- Repeat the process for all additional phase contrast objectives.
- Remove the centering keys after centering.

Fig. 96 Condenser with motorized polarizer

1 Centering key for polarizer

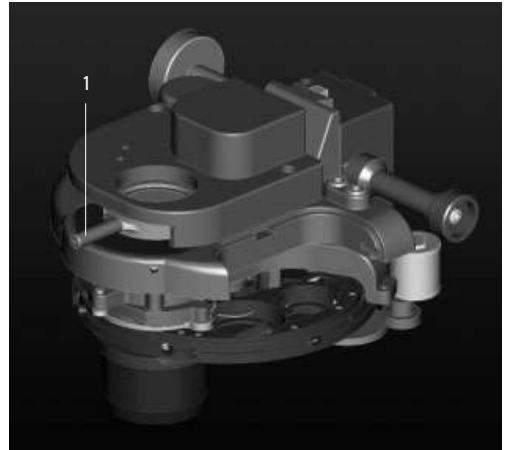

Fig. 97 Condenser centering

1 Centering openings

2 Height adjuster

3 Prism and phase ring centering



Integrated phase contrast with bright field objectives via front slider

When choosing an objective suitable for phase contrast, the appropriate light ring is selected automatically when using a motorized condenser. Otherwise, select the light ring manually.

Centering the phase rings is not required for objectives with eyepoint A. Checking the position of the phase rings is essential only when using objectives with eyepoint C.

(For the eyepoint of your objective, please refer to the included objective list or the engraving on the objective itself.)

- Move the front slider with the phase rings into the beam path.

Leica DMI3000 B:

- If necessary, adjust the TL bright field position at the filter slider.
- Set the condenser to the bright field position.

Leica DMI4000 B and Leica DMI6000 B:

- Press the BF (bright field) button (one of the variable function buttons on the stand).
- Select the objective with the lowest magnification.
- Focus on the specimen.
- Select the objective with the lowest magnification and eyepoint C.

Leica DMI3000 B:

- Select the light ring for your current objective on the condenser.

Leica DMI4000 B and Leica DMI6000 B:

- Press the PH (phase contrast) button (one of the variable function buttons behind the focus wheels). The light ring will be selected in the condenser.
- Slide the front slider with the phase rings to position C (A and C refer to the eyepoint of the objective. For the eyepoint of your objective, please refer to the included objective list or the engraving on the objective itself.)
- Instead of an eyepiece, place a focusing telescope (Fig. 93) in the observation tube or activate the Bertrand lens (pull rod (94.1) on tube).
- Focus the ring structure (95a) by loosening the clamping ring (93.2) somewhat and moving the eyelens (93.1), or focus the Bertrand lens (94.2).
- Retighten the clamping ring.
- If the light ring and the phase ring are not shown as arranged in Fig. 95c, the light ring must be centered.
- Insert the centering key in the opening provided on the front slider
- Turn the centering keys until the dark ring (phase ring in the objective) is congruent with the slightly narrower bright ring (light ring in condenser) (95 c).
- Remove the centering keys after centering.

7.8 Checking modulation contrast slit diaphragms

If your microscope is prepared for integrated modulation contrast, its condenser will be equipped with slit diaphragms suitable for the objectives.

The slit diaphragms have been centered at the factory.

Their proper location should be checked, however.



Note:

Each objective has its own slit diaphragm assigned to it in the condenser disk. The test must therefore be performed for each objective.

Open the cover at the top right side of the condenser. The various numbered openings for the inserts are now visible. Ensure that all of the slit diaphragms are firmly seated and that none of the retaining screws are loose. If a part has loosened, please see Chapter 6.5 Installation of Condensers.

7.9 Setting the Motorized Polarizer

Remove your specimen from the stage.

Leica DMI3000 B:

- Set the condenser to the bright field position.
- Insert the analyzer into the analyzer slot on right side of the stand.
- Activate the polarizer.
- Turn the polarizer until you have the optimal dark position.

Leica DMI4000 B and Leica DMI6000 B:

For manual condensers, proceed as described above for the DMI3000 B.

- Select the POL method (one of the variable function buttons on the stand). If the analyzer is present on the Fluo turret as an analyzer block, it will move into position automatically. A manual analyzer must be positioned by hand. In the case of motorized condensers with motorized polarizers, the polarizer will move into position automatically.
- Insert the centering key in the opening provided on the condenser (Fig. 96).
- Set up optimal darkening. (The analyzer must be in place.)
- Remove the centering keys.

Replace your specimen on the stage.

7.10 Adjusting the Light Sources



Caution!

The lamp and the lamp housing may still be hot.

Transmitted light axis (TL) with lamp housing 107/2

The lamp housing 107/2 with a 12V 100W halogen lamp is fixed. Centering the lamp is not required.

Lamp housing 107 L for 12V 100W halogen lamp

The lamp can be adjusted using the screws (98.2) and the button (98.3).

- Place a sheet of white paper under the field diaphragm.
- Adjust the lamp to create an evenly bright spot on the paper.

Fig. 98 Lamp housing 107 L

- 1 Mounting for housing
- 2 Screw for vertical adjustment
- 3 Button for horizontal adjustment
- 4 Collector focusing

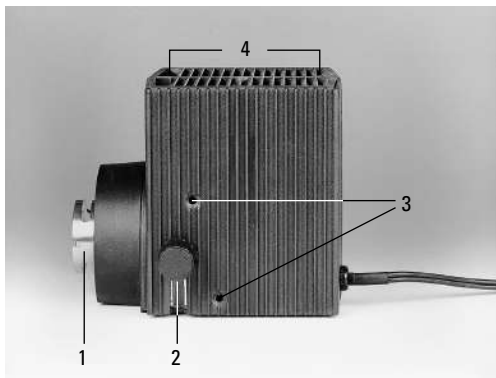

Incident light axis (IL) with lamp housing 106 z

- When a supply unit is used, it is turned on first.
- Activate the incident light axis (for Leica DMI4000/6000 B with the **TL/IL** function button. **FLUO** will appear on the LeicaScreen).
- Insert the lamp adjustment reflector (Fig. 99) in the filter turret in place of a filter cube. Make a note of the designation of the replaced filter cube.



Note:

To avoid adjustment errors, neighboring filter cubes must also be removed.

- Turn the reflector into the beam path. For Leica DMI4000/6000 B: The reflector is correctly positioned when the LeicaScreen shows the designation of the replaced filter cube.

Fig. 99 Reflector cube for lamp adjustment

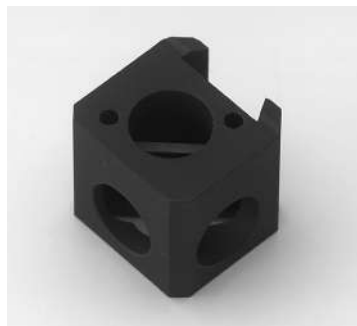



Caution!

Never look directly into the beam path!
Beware of the glare hazard when switching to reflector BF or Smith!



Caution!

Light sources pose a potential irradiation risk (glare, UV-radiation, IR-radiation).

In the lamp housing 106z, the direct image of the filament (in halogen lamps) or the arc (in gas discharge lamps) and its reflection are focused separately and adjusted in relation to one another.

An adjustment window (2.8, p. 22; 5b.3, S.26) in which the light source is visible is located on the right side of the microscope.

Adjust the lamp as follows while observing the light source in the adjustment window.

Centering the Hg 100 W and Xe 75 W mercury lamps

- The adjustment window shows the direct image of the arc and its mirror image. These are generally not in alignment with one another.
- Focus the direct image with the collector (100.6).
- Use the adjusting buttons to pivot the arc's mirror image on the rear side of the lamp housing (100.2, 100.4) to the side or completely out of the beam path. The arc's focused image remains visible (Fig. 101).
- Use the adjusting buttons (100.1 and 100.5) to place the direct arc image in the middle of the centering plane, whereby the bright tip of the arc, the focal spot, should lie slightly outside the center (Fig. 102).

Fig. 100 Lamp housing 106z L

- 1 Lamp adjustment, vertical
- 2 Vertical reflector adjustment
- 3 Focusing the reflector image
- 4 Horizontal reflector adjustment
- 5 Lamp adjustment, horizontal
- 6 Collector focusing
- 7 Screw

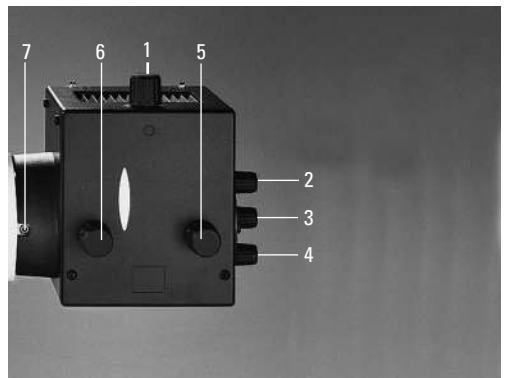

- Then pivot the arc's mirror image with the adjusting knobs (100.2) and (100.4) and focus it using the reflector (100.3).
- Use the adjusting knobs (100.2) and (100.4) to orient the mirror image symmetrically to the direct image (Fig. 103).
The V-shaped irradiation of the direct image and mirror image arcs can be superimposed.

**Caution!**

The bright tips of the arcs, the focal spots, must never be projected onto each other, as this results in a danger of explosion by overheating.

**Caution!**

The structure of the arc can no longer be made out clearly in lamps that have been in service for a long time. The image and mirror image can no longer be superimposed exactly. In this case, align both images.

- Using the collector, defocus the image with the knob (100.6) until the arc image and mirror image are no longer recognizable and the image is homogeneously illuminated.
- Replace the lamp adjustment reflector with the original filter cube.
Note:
Make sure to switch off the instrument.

Fig. 101 Direct arc image focused but not centered (in reality, the image is less focused)

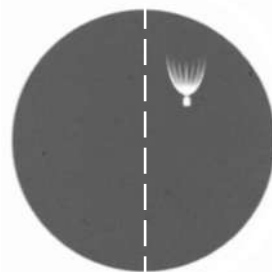

Fig. 102 Direct arc image in target position (in reality, the image is less focused)

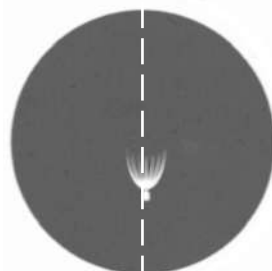
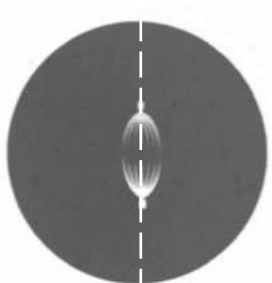

Fig. 103 Direct arc image and mirror image in target position (in reality, the image is less focused)



8. Operation

8.1 Switching on

When using a gas discharge lamp, the ebq 100 external supply unit must be turned on separately (104.1).

Leica DMI3000 B:

- Switch on the microscope's power at the On/Off switch. The signal lamp is lit when the instrument is ready. (Continue with Chapter **8.2 Contrast Methods**)

Leica DMI4000 B and Leica DMI6000 B:

- Switch on the power of the electronics box at the On/Off switch (105.1). The signal lamp (105.2) is lit green when the unit is ready. All motorized microscope components will then run through an initialization phase.



Note:

If a PC is connected, switch on **the electronics box first**, and **then the computer**.

All motorized microscope components will then run through an initialization phase.



Note:

In the case of faulty initialization („Init Error“ message on LeicaScreen), see Troubleshooting chapter, → p. 106.

Fig. 104 Front panel of ebq 100 supply unit

- 1 Power switch
- 2 Lamp status

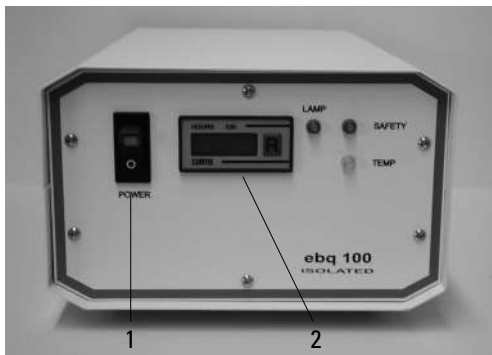
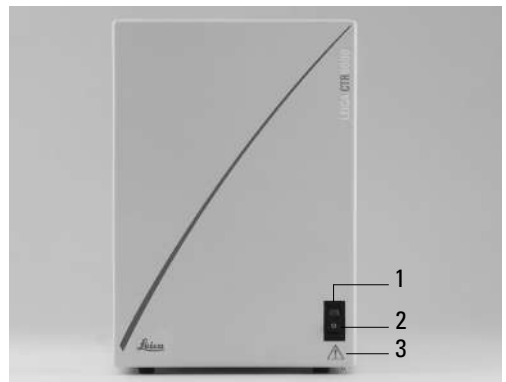

Fig. 105 front side Leica CTR6000

- 1 On/Off switch
- 2 Signal lamp
- 3 Warning: Regard safety notes!



All of the user's previous settings are restored during the initialization.



Caution:

The focal position and the lower stop are also retained from one session to the next when power is switched off.

After the initialization is complete, the LeicaScreen will display the status screen with microscope's current settings. Fig. 107 is an example.



Note: (reset function)

The microscope can be reset to its factory default programming:

- With the stand switched off, press the top three variable function buttons on the left side of the stand.
- Switch on the power for the stand.
- Hold the buttons until the initialization is complete.
- The standard information display will now appear in the LeicaScreen (Fig. 106 and 107).
- Switch the instrument off and back on. The settings are now saved.

Fig. 106 LeicaScreen initialization



Fig. 107 LeicaScreen following initialization

	FLUO>DIC	
	40x Obj. IMM	
	1.5x MagCh.	Σ 600x
	INT 100% B G	+1 +2
	AP 33	FD 30
	80%	20%
	- 0.55 mm	coarse

8.2 Contrast Methods

All of the contrast methods of the Leica DMI4000 B and Leica DMI6000 B can be selected and controlled via the variable function buttons and the Leica Application Suite (LAS). The only exceptions are methods that involve components requiring manual control (e.g. systems with manual analyzers). The following section describes the use of the function buttons on the stand. For instructions on the use of the software, please refer to the separate manual.

Contrast methods for the Leica DMI3000 B are controlled via the manual condenser, the manual objective turret, as well as turning knobs and sliders at the microscope.

8.2.1 Bright Field (TL)

Leica DMI3000 B:

- If necessary, adjust the TL bright field position at the filter slider.
- Set the condenser to the bright field position.
- Remove all other optical components such as analyzers, polarizers or IC prisms from the beam path.
- Insert a transmitted light specimen.
- Select your objective
- Set the brightness at the light potentiometer
- Focus the image with the focus wheels.

Leica DMI4000 B and Leica DMI6000B:



Note:

If all positions of the filter turret are occupied, filter cube „A“ can be swapped for filter cube „A-TL“ using the Leica Application Suite (LAS/LAS AF). TL contrast methods are possible with that filter cube.

- Use the **TL/IL** function button to switch to transmitted light (TL).
- Select the **BF** (bright field) contrast method by pressing the variable button **BF**. Alternatively: press the variable button **CHANGE TL** . (For details on button assignments, please see the identification sheet.) **BF** will appear on the LeicaScreen. Motorized condensers will now move to the bright field position. Coded condensers must be switched manually. The fluorescence filter turret will automatically go to an empty position or to the „A-TL“ filter cube.
- Insert a transmitted light specimen.
- Rotate an appropriate objective into place.
- Focus the image with the knob on the Smart-Move or the focusing wheel and adjust the intensity with the **INT** function buttons.

Fig. 108 Function buttons (left side of stand)

- 1 variable function buttons
- 2 Open/close aperture diaphragm
- 3 TL/IL switching
- 4 Open/close field diaphragm
- 5 Increase/decrease light intensity

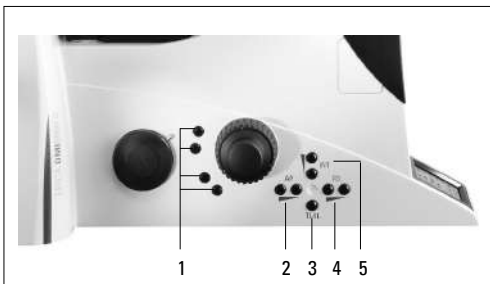
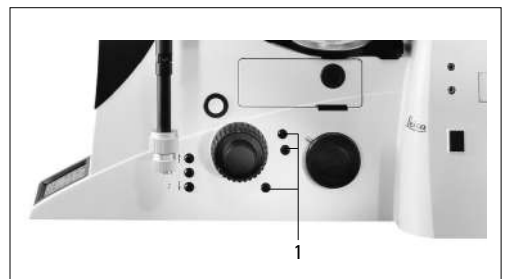

Fig. 109 Function buttons (right side of stand)

- 1 variable function buttons



8. Operation

8.2.2 Phase Contrast (TL) (integrated phase contrast, see 8.2.6)

Leica DMI3000 B:

- If necessary, adjust the TL bright field position at the filter slider.
- Select a phase contrast objective.
- Select the suitable light ring on the condenser.
- Open the aperture of the condenser completely.
- Remove all other optical components such as analyzers, polarizers or IC prisms from the beam path.
- Insert a phase contrast specimen.
- Set the brightness at the light potentiometer
- Focus the image with the focus wheels.

Leica DMI4000 B and Leica DMI6000 B:

- Use the **TL/IL** function button to switch to transmitted light (TL).
- Select the **PH** (phase contrast) contrast method by pressing the variable button **PH**.
Alternatively: press the variable button **CHANGE TL** .
(For details on button assignments, please see the identification sheet.)
PH will appear on the LeicaScreen.
Motorized condensers will now switch to the correct light ring. Coded condensers must be switched manually.
- Insert a transmitted light specimen.
- Rotate an appropriate objective into place.
Objectives that are suitable for phase contrast are engraved with PH.
- Focus the image with the knob on the Smart-Move or the focusing wheel and adjust the intensity with the **INT** function buttons.



Note:

When selecting the phase contrast method, the aperture diaphragm is opened fully and can not be adjusted.

8.2.3 Dark Field (TL)



Note:

The maximum usable objective aperture for dark field is for the condenser S1 0.70 and for the condenser S23/S28 0.40.

Leica DMI3000 B:

- If necessary, adjust the TL bright field position at the filter slider.
- Select a dark field objective.
- Select the suitable dark field stop on the condenser.
- Open the aperture of the condenser completely.
- Remove all other optical components such as analyzers, polarizers or IC prisms from the beam path.
- Insert a dark field specimen.
- Set the brightness at the light potentiometer
- Focus the image with the focus wheels.

Leica DMI4000 B and Leica DMI6000 B:

- Use the **TL/IL** function button to switch to transmitted light (TL).
 - Select the **DF** (dark field) contrast method by pressing the variable button **BF**.
Alternatively: press the variable button **CHANGE TL** .
- (For details on button assignments, please see the identification sheet.)
- DF** will appear on the LeicaScreen. Motorized condensers will now switch to the dark field ring. Coded condensers must be switched manually.
- Insert a transmitted light specimen.
 - Rotate an appropriate objective into place.
 - Focus the image with the knob on the Smart-Move or the focusing wheel and adjust the intensity with the **INT** function buttons.

When selecting the dark field method, the aperture diaphragm is opened fully and can not be adjusted.

8. Operation

8.2.4 Polarization (TL)

Leica DMI3000 B:

- If necessary, adjust the TL bright field position at the filter slider.
- Select an objective.
- Set the condenser to the bright field position.

Remove all IC prisms from the light path.

- Move the polarizer on the condenser into the beam path.
- Insert the analyzer into the right side of the stand until it clicks into position.
- Bring the polarizer and analyzer into cross position until they reach maximum darkness.
- Insert a specimen.
- Set the brightness at the light potentiometer
- Focus the image with the focus wheels.

Leica DMI4000 B and Leica DMI6000 B:

- Use the **TL/IL** function button to switch to transmitted light (TL).
- Select the **POL** (polarization) contrast method by pressing the variable button **POL**.
Alternatively: press the variable button **CHANGE TL** .
(For details on button assignments, please see the identification sheet.)
POL will appear on the LeicaScreen.

Manual method:

- Move the polarizer on the condenser into the beam path.
- Insert the analyzer into the right side of the stand until it clicks into position (Fig. 110).
- Bring the polarizer and analyzer into cross position until they reach maximum darkness.
- Place a specimen on the stage and select a suitable objective.

Motorized method:

- If the microscope is equipped with the relevant components, the polarizer will be activated automatically in the condenser when the **POL** contrast method is selected. The analyzer cube is also automatically positioned in the beam path.

Combined methods:

- The Leica DMI4000 B and Leica DMI6000 B microscope permit purely mechanical and motorized components – such as a mechanical analyzer and motorized polarizer – to be combined.

Fig. 110 Inserting the analyzer



8.2.5 Differential Interference Contrast (TL)

Leica DMI3000 B:

- If necessary, adjust the TL bright field position at the filter slider.
- Select an objective.
- At the condenser, select the appropriate Wollaston prism condenser.
- At the objective turret, select the appropriate Wollaston prism objective.
- Move the polarizer on the condenser into the beam path.
- Insert the analyzer into the right side of the stand until it clicks into position.
- Insert a specimen.
- Set the brightness at the light potentiometer
- Focus the image with the focus wheels.
- Use the knurled wheel below the objective turret for fine adjustment (Fig. 111).

Leica DMI4000 B and Leica DMI6000 B:

- Use the **TL/IL** function button to switch to transmitted light (TL).
- Select the **DIC** contrast method by pressing the variable button **DIC**.
Alternatively: press the variable button **CHANGE TL** .
(For details on button assignments, please see the identification sheet.)
DIC will appear on the LeicaScreen.

- The polarizer in the condenser and the suitable condenser prism are automatically positioned in the beam path. The corresponding objective prism and the analyzer cube are also positioned automatically.
- Place a DIC specimen on the stage.
- Rotate an appropriate objective into place.
- Focus the image with the knob on the Smart-Move or the focusing wheel and adjust the intensity with the **INT** function buttons.
- Use the knurled wheel below the objective turret for fine adjustment (Fig. 111).

Manual alternative:

- Move the polarizer on the condenser into the beam path manually.
- Insert the analyzer manually into the right side of the stand until it clicks into position (Fig. 110). Adjust the objective and condenser prisms manually until a valid combination appears on the display.
- Use the knurled wheel below the objective turret for fine adjustment (Fig. 111).

Fig. 111 DIC disk with knurled wheel for fine adjustment



8. Operation

8.2.6 Integrated Phase Contrast (TL)

Leica DMI3000 B:

- If necessary, adjust the TL bright field position at the filter slider.
- Select a bright field objective with eyepoint B or C.
- Select the appropriate light ring at the condenser (see table).
- Open the aperture of the condenser completely.
- Remove all other optical components such as analyzers, polarizers or IC prisms from the beam path.
- Slide the phase contrast front module to the correct eyepoint, B or C.
- Insert a phase contrast specimen.
- Set the brightness at the light potentiometer
- Focus the image with the focus wheels.

Leica DMI4000 B and Leica DMI6000 B:

- Use the **TL/IL** function button to switch to transmitted light (TL).
- Select the IPC contrast method (integrated phase contrast). by pressing the variable button IPH. Alternatively: press the variable button **CHANGE TL** . (For details on button assignments, please see the identification sheet.) PH will appear on the LeicaScreen. Motorized condensers will now switch to the correct light ring. Coded condensers must be switched manually.
- Insert a transmitted light specimen.
- Select a suitable objective (eyepoint B or C).
- Slide the phase contrast front module to the correct eyepoint, B or C.
- Focus the image with the knob on the Smart-Move or the focusing wheel and adjust the intensity with the INT function buttons.



Note:

When selecting the phase contrast method, the aperture diaphragm is opened fully and can not be adjusted.

IP0	for 5x,	e.g. NPlan 5x	objective with eyepoint B
IP1	for 10x, for 20x,	e.g. NPlan 10 x e.g. NPlan L 20 x	objective with eyepoint B and objective with eyepoint C
IP2	for 40x,	e.g. HCX PL FL L 40 x	objective with eyepoint C
IP3	for 63x,	e.g. PL FL 63x/0.70	objective with eyepoint C

8.2.7 Integrated Modulation Contrast (TL)

Leica DMI3000 B:

- If necessary, adjust the TL bright field position at the filter slider.
- Select a bright field objective with eyepoint B or C.
- Select the slit illumination suitable for the magnification at the condenser.
- Move the polarizer on the condenser into the beam path.
- Remove all other optical components such as analyzers or IC prisms from the beam path.
- Slide the IMC front module to the correct eyepoint, B or C.
- Insert a specimen.
- Set the brightness at the light potentiometer
- Focus the image with the focus wheels.
- Use the knurled wheels on the slider and the polarizer for fine adjustment.

Leica DMI4000 B and Leica DMI6000 B:

- Use the **TL/IL** function button to switch to transmitted light (TL).
- Select the IMC contrast method (integrated modulation contrast). by pressing the variable button IMC.
Alternatively: press the variable button **CHANGE TL** .
(For details on button assignments, please see the identification sheet.)
IMC will appear on the LeicaScreen. If you have a motorized condenser, the correct slit diaphragm and polarizer will be activated automatically. Coded condensers must be switched manually.
- Insert a specimen.
- Select a suitable objective (eyepoint B or C).
- Slide the IMC front module to the correct eyepoint, B or C.
- Focus the image with the knob on the Smart-Move or the focusing wheel and adjust the intensity with the INT function buttons.
- Use the knurled wheels on the slider and the polarizer for fine adjustment.

8. Operation

8.3 Fluorescence

Leica DMI3000 B:

The filter slider (5a.9, p.25) is used to operate the fluorescence module.

- Pull the filter slider out completely to open the beam path.
- Push the filter slider into the middle position (1st detent) to bring the blue filter into the beam path.
- Insert the filter slider fully in order to block the beam path (shutter position).
- The fluorescence illumination is controlled by the rotary knob (5a.10, p.25).
- The filter cubes are swiveled manually into the beam path by turning the incident light turret disk.

Leica DMI4000 B and Leica DMI6000 B:

- Use the **TL/IL** function button to switch to fluorescence **FLUO**.
- Place a specimen on the stage and select a suitable objective.
- The current fluorescence filter cube will be displayed on the LeicaScreen.
- You may protect your specimen from fading by closing the incident light shutter. To do so, press the **SHUTTER** button (87.3) on the front panel. The following pictogram will appear on the LeicaScreen:



► **Changing the fluorescence filter cube**

- Fixed function buttons on the front panel: **CUBE 1** to **CUBE 6** or **Cube CCW**
- Variable function buttons on the front panel and SmartMove: **CUBE CW** or **CUBE CCW**
- Leica Application Suite (LAS) Software

- Focus the image with the knob on the SmartMove or the focusing wheel and adjust the intensity with the **INT** function buttons.

Options

- The intensity of the fluorescence can be increased by using the booster lens (Fig. 112) on the left rear side of the stand (Fig. 113).
If bright fluorescence is required in the center of the field of view, slide the booster lens into the receptacle with the marking 1.4x facing the user. If a homogeneous distribution over the entire field of view is required, turn the booster lens 180° so that the marking 0.7x is facing forward.
- For multiple fluorescence, we recommend using the Excitation Manager and/or the ultrafast internal filter wheel. Excitation wavelengths can thus be changed in milliseconds. They are controlled by the function buttons.

Fig. 112 Booster lens



Fig. 113 Booster lens in stand

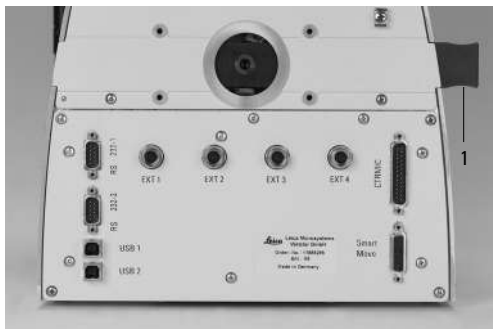



8.4 Combination Methods

(Leica DMI4000 B and DMI6000 B)

Up to two combination methods are possible depending on the features of the individual microscope:

FLUO/PH and FLUO/DIC

- Select the combination method by pressing the variable button **COMBI**  .
Alternatively: press the variable button **CHANGE COMBI**  .
(For details on button assignments, please see the identification sheet.)
The content of the display changes accordingly.
- Place a specimen on the stage and select a suitable objective.
- Select the desired filter cube using the fixed function buttons on the front panel.
- The illumination settings for the fluorescence and transmitted light axes can be adjusted separately.
- Toggle the illumination axes with the **TL/IL** function button. The content of the LeicaScreen changes accordingly.

FLUO > DIC

The transmitted illumination is activated.

FLUO < DIC

The fluorescence illumination is activated.



Note:

The manual analyzer (Fig. 110) must be used for the FLUO/DIC method as described in Chapter 8.2.5, p. 89.

8.5 Focusing

Leica DMI3000 B and Leica DMI4000 B:

The left-hand focus wheels can be used for both coarse and fine focusing; the right-hand focus wheel for fine focusing only (a version of the Leica DMI3000 B with mirrored focus controls is also available)

Leica DMI6000 B:



Note:

The parfocality teach-in has already been performed at the factory. However, it may be necessary to perform another teach-in after installing the objectives when setting the microscope up. We recommend checking parfocality before setting the stops and performing a teach-in with the Leica Application Suite (LAS) if necessary.

Focusing the image

The focusing is controlled by the knob (116.3, p. 102) on the SmartMove remote control module.

Abb. 114

- 1 Focus operating keys
- 2 Open filter drawer

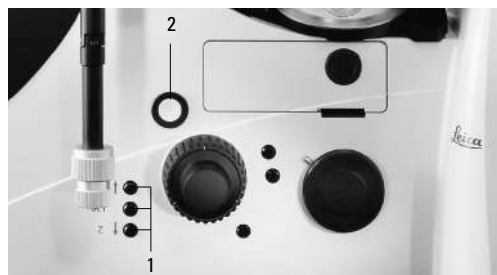

Alternatively, use the focus wheels on either side of the stand.

The current Z position is shown on the LeicaScreen. In the case of motorized stages, the Z drive will travel to its lowest position prior to the stage initialization when switching the microscope on.

The focus buttons $Z\uparrow$ and $Z\downarrow$ on the right side of the stand (Fig. 114) permit fast focusing or lowering of the objectives.

Setting stops

Set the lower focus stop by pressing and holding the **SET** button and pressing the $Z\downarrow$ button as well.

The display will show ∇ .

Pressing the button combination again will delete the stop.

The display will show ∇ .

The lower focus stop can also be set using the Leica Application Suite (LAS).

The **lower stop** is the same for all objectives and can not be traversed.

In addition, a **focus position** that can not be traversed can also be set.

To do so, press and hold the **SET** button and press the **Z** button as well.

The display will show \boxtimes .

Pressing the button combination again will delete the stop.

The display will show \boxtimes .

The focus position can also be set using the Leica Application Suite (LAS).

Set the focus position for the dry objective at the highest magnification. The focus positions will then be set automatically for all other objectives, taking parfocality and working distances into account.

► Set the stops via

- fixed function buttons on stand
- Leica Application Suite (LAS) Software

Summary of pictograms

- ▼ lower focus stop not set
- ▼ lower focus stop set
- ▼ focus position not set
- ▼ focus position set

Going to the stops

Go to the lower stop by pressing and holding the **Z↓** button.

Go to the focus position by pressing and holding the **Z↑** button.

These functions can be assigned to variable function buttons on the stand or SmartMove, or they can be controlled via software.

► Go to stops via

- fixed function buttons on stand
- variable function buttons on stand and SmartMove
- Leica Application Suite (LAS) Software



Note:

When going to the stops with the **Z↑** and **Z↓** buttons, hold the button until the stop has been reached.

Setting the step increments

It is possible to toggle between **Fine** and **Coarse** step increments.

The **Fine** value varies to suit the current objective. Suitable values have been predefined. The assignments can be changed with the Leica Application Suite (LAS). When selecting **Coarse**, the positioning speed is the same for all objectives. **Coarse** corresponds to the maximum speed.



Note:

The assignment of a specific step increment to an objective not only applies to the Z drive, but also to the step increments assigned to the stage when **Precise** (→ p. 102) is selected.

► Switch between Fine and Coarse via

- variable function buttons on stand and SmartMove
- Leica Application Suite (LAS) Software

Only for DMI6000 B with AFC (Adaptive Focus Control)

AFC actively holds a pre-defined focus position over time. This feature is especially useful, if e.g. during a time-lapse experiment at 37°C the climate chamber has to be opened and a drop of the temperature may occur.

Activate the AFC function, focus on your specimen either with the hand wheel on the microscope stand or at the SmartMove and store the current focus position as hold position.

AFC can be controlled either by.

- Variable function keys at the stand or SmartMove
- STP6000
- Software (Leica LASAF)

8.6 Tubes



Note:

Close any unused tube openings, as otherwise stray light can interfere with observation.

Adjusting the viewing distance

- Adjust the viewing distance of the eyepieces so that a congruent total image is seen (Fig. 115).

Adjusting the viewing angle

- Ergotubes feature a tilting binocular section for a 30–45° viewing angle adjustment range.

Beam splitting in photo tubes

The beam splitting is set manually by pulling out a control bar.

	Observation	photo
	100%	0%
	0%	100%
alternatively	50%	50%
BL	activation of Bertrand lens*	

► **Light distribution via**

► manual control bar

8.7 Port selection

Leica DMI 3000 B and Leica DMI4000 B:

Manual shifter rod activates and deactivates the left-hand photo port.

	VIS	LEFT
	100%	0%
	20%	80%
alternatively:	0%	100%

Leica DMI 6000 B:

The



button on the front control panel switches 100% of the light to the eyepieces.

Use the



button, also on the front control panel, to select the side ports.



Fig. 115 Tube setting

8. Operation

Depending on the configuration, the screen will now display

- the active port (right or left) and
- the percentage of light going to the port (100%, 80%, 50%).

Optional Leica DMI 6000 B:

The bottom port selection function can be assigned to one of the variable function buttons on the stand or the SmartMove.

The top port can only be selected manually.

► Select ports via

- fixed function buttons on stand (side ports)
- variable function buttons on stand and SmartMove (bottom port)
- manual action (top port)

8.8 Eyepieces



Note:

The eyepiece's aperture protector must be removed or folded back, during microscopy while wearing eyeglasses. We recommend removing bifocals and spectacles with progressive-addition lenses when using the microscope.

- For the adjustable tubes with documentation output, choose the 100% VIS position.

Eyepieces with inlaid reticle

- Focus the reticle by adjusting the eyelens.
- Focus on the object through this eyepiece.
- Then, close that eye and focus on the object by adjusting only the second ocular.

Correction for Vision Problems

- With your right eye, look through the right eyepiece and bring the specimen into sharp focus.
- Then, with your left eye, view the same specimen and rotate the left eyepiece tube until the object is brought into sharp focus. Do not change the Z position in the process!

**Note:**

We recommend running a teach-in via the Leica Application Suite (LAS) software when using eyepieces not included in the scope of delivery. This will ensure that the total magnification shown in the LeicaScreen is correct.

8.9 Objectives

Changing objectives

Leica DMI3000 B and Leica DMI4000 B:

Select objectives manually with the objective turret.

The objective turret of the DMI4000 B is coded so that the selected objective is shown on the display.

Leica DMI6000 B:

The objectives can be selected with the function buttons on the stand or the SmartMove, or by manually turning the objective turret. When changing objectives manually, please ensure that the turret clicks into position.

The positions of the objectives in the objective turret have been specified at the factory and must be observed when installing the objectives. (→ also see Objectives, p. 44).

When selecting an objective, the microscope automatically selects:

- the optimal setting for the field diaphragm
- the optimal setting for the aperture diaphragm
- the light intensity for the current contrast method

The objective magnification and total magnification are displayed on the LeicaScreen.

8. Operation

- For **immersion objectives** use the appropriate immersion medium.

OIL: only use optical immersion oil according to DIN/ISO standards.
Cleaning → p. 110.

W: Water immersion.

IMM: Universal objective for water, glycerol, oil immersion.



Caution!

Follow safety instructions for immersion oil!

Color coding of objectives

The magnification of each objective is indicated by a color ring in accordance with DIN/ISO standards:

100x 125x 150x 160x	63x	40x 50x	25x 32x	16x 20x	10x	6.3x	4x 5x	2.5x	1.6x
white	dark-blue	light-blue	dark-green	light-green	yellow	orange	red	brown	gray

Immersion objectives are marked by an additional, lower color ring.

black oil or Imm (universal objective for oil, water or glycerin)

white water

orange glycerin

The various engraved markings of the objectives provide information on their applications:

black or bright field objectives,
dark blue strain-free
green phase contrast objectives,
strain-free

▶ Select objectives via

- ▶ variable function buttons on stand and SmartMove
- ▶ Leica Application Suite (LAS) Software
- ▶ Manual selection

Changing the operating modes „dry“ (DRY) and „immersion“ (IMM)

Each objective is assigned to a specific objective category:

- 1) Dry objectives (DRY)
- 2) Immersion objectives (IMM)



Note:

It is possible to use objectives for both operating modes.

The mode can be assigned in the Leica Application Suite (LAS).

Changing the operating mode

- First, select the operating mode (Imm or Dry) using the function buttons.
The operating mode may also be selected in the Leica Application Suite (LAS).
- The objective turret is lowered to its bottom stop. This is to permit the application of the immersion liquid when changing from a dry to an immersion objective. It also permits the removal of the liquid when changing to dry mode. The current objective remains in the beam path.

- Next, press the but on for the objective you intend to use.



Note:

If the **Imm** or **Dry** operating mode buttons are pressed accidentally, the original mode can be restored by pressing the appropriate button.

▶ Change operating mode via

- ▶ variable function buttons on stand and SmartMove
- ▶ Leica Application Suite (LAS) Software



Note:

When replacing objectives, you must perform a teach-in for the new objectives in the Leica Application Suite (LAS). A parfocality teach-in should also be performed.



Note:

For lockable immersion objectives lock these by pushing the front part upwards until it stops (approx. 2 mm). Then, after a gentle turning motion to the right, the objective is locked.

For objectives with corrective mounts turn the knurl to adjust the objective to the thickness of the cover glass.

8. Operation

8.10 Stages and Object Displacement

Leica DMI3000 B and Leica DMI4000 B:

The motorized stages are controlled via a separate control unit.

Leica DMI6000 B:

Object displacement using SmartMove

The positioning of the stage is controlled by the knobs (116.1, 116.2) on the SmartMove remote control module.

Setting the step increments

The positioning speed of the stage can be varied by switching between the **Fast** and **Precise** step increments.

When selecting **Fast**, the positioning speed is the same for all objectives.

The **Precise** speed varies to suit the current objective.

Storing and restoring stage positions

A variety of stage positions can be stored temporarily in the Leica Application Suite (LAS). The XY position is stored, not the Z position.

In addition to a loading position (Load), 5 stage positions can be set temporarily. When switching the microscope on, the stage will travel to a previously-defined starting position.

► **Temporarily store and restore stage positions via**

- Leica Application Suite (LAS) Software

► **Switch between Precise and Fast via**

- variable function buttons on stand and SmartMove
- Leica Application Suite (LAS) Software

Fig. 116 SmartMove remote control module

- 1 travel in x
- 2 Travel in y
- 3 Focus
- 4 Individual adjustment of button height
- 5 Variable function buttons (factory preset)

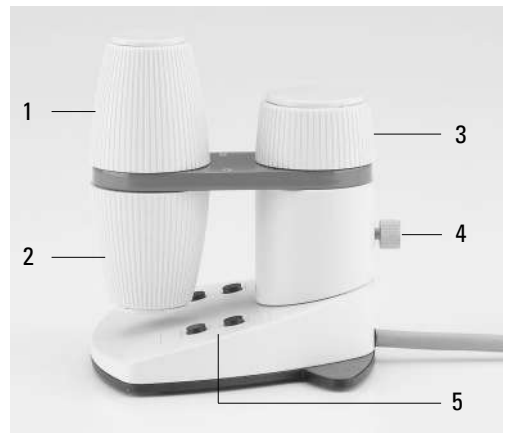

8.11 Magnification Changer

Leica DMI3000 B:

A mechanical magnification changer can be used optionally.

Magnification factor: 1.6x.

A slider switches between 1x and the magnification factor. The mechanical magnification changer affects the eyepieces and the top port.

Leica DMI4000 B and Leica DMI6000 B:

A mechanical magnification changer can be used optionally. The following magnification factors are available: 1.5x, 1.6x and 2x

A slider switches between 1x and the magnification factor.

The mechanical magnification changer affects the eyepieces and the top port.

The selected factor is shown in the LeicaDisplay or the relevant window of the Leica Application Suite (LAS) and taken into account when calculating the total magnification.

Leica DMI4000 B and Leica DMI6000 B:

A motorized magnification changer can be used optionally. The following magnification factors may be selected: 1.5x, 1.6x, or 2x

The selected factor is displayed on the LeicaScreen and in the relevant field of the Leica Application Suite (LAS), and is taken into account when calculating the total magnification. The motorized magnification changer affects all ports.

Pressing the left button (117.1) switches between the possible magnification factors; pressing the right button selects the factor 1x.



Note:

a microscope can not have both types (manual and motorized) of magnification changers.

Fig. 117 Front control panel

1 Function buttons for magnification changer



► Change magnification via

- fixed function buttons on stand
- Leica Application Suite (LAS) Software

8. Operation

8.12 Light sources

Leica DMI3000 B:

- Light intensity: the transmitted light intensity can be adjusted continuously from 0 to 12V using the potentiometer at the lower left of the front of the microscope stand.
- FLUO: The intensity can be adjusted in 5 fixed levels via the rotary knob (5a.10, p. 25).
100% / 55% / 30% / 17% / 10%
(FIM=Fluorescence Intensity Manager)
If you continue turning to the left at 100% or to the right after 10%, a 0% position (shutter position) is set.

Leica DMI4000 B and Leica DMI6000 B:

- Adjust the intensity with the function buttons (118.4). The INT function buttons are always assigned to the currently active transmitted light (TL) or incident light (IL) axis.
- For TL and IL:
The setting can be made in coarse and fine steps. Pressing both INT (118.2) buttons at the same time toggles between coarse and fine adjustment. The light intensity displayed on the LeicaScreen changes accordingly.
Coarse adjustment: 0–20
Fine adjustment: 0–255
- The intensity is individually adjusted and stored for each objective and contrast method.

- FLUO: The intensity can be adjusted in 5 fixed levels.
100% / 55% / 30% / 17% / 10%
(FIM=Fluorescence Intensity Manager)

► Adjust intensity via

- fixed function buttons on stand
- variable function buttons on stand and SmartMove
- Leica Application Suite (LAS) Software

Fig. 118 Fixed function buttons, left side of stand

- 1 Aperture diaphragm
- 2 Transmitted light/incident light
- 3 Field diaphragm
- 4 Light intensity

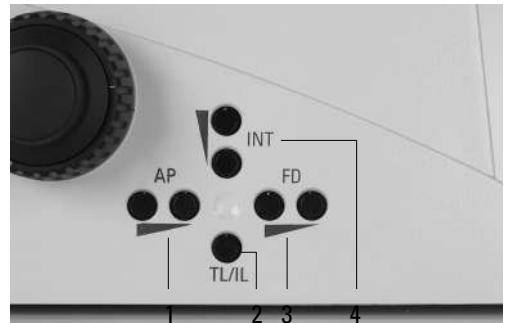

8.13 Aperture and Field Diaphragm

Leica DMI3000 B:

Transmitted light:

- The manual aperture diaphragm is adjusted on the condenser.

- The manual field diaphragm is adjusted on the illumination arm.

Incident light:

- The field diaphragm is set via the rotary knob (5a.11, p. 25). Diaphragm apertures of different sizes (round or angled) can be selected. (See the labeling on the rotary knob.) Round apertures are suitable for observations through the eyepieces; angled apertures are suitable for observations with CCD cameras.

Leica DMI4000 B and Leica DMI6000 B:

Both diaphragms have been set to suitable values for the current objective and contrast method at the factory.

The aperture diaphragm is controlled manually when using the manual condenser.

The field diaphragm is controlled manually when using the manual illumination arm.

- The motorized diaphragms can be adjusted at any time with the **AP** (aperture diaphragm) (118.1) and **FD** (field diaphragm) (118.3) function buttons. The values displayed on the LeicaScreen change accordingly.

The function buttons are assigned to the currently active transmitted light (TL) or incident light (IL) axis.

Microscopes with structured illumination are not equipped with a field diaphragm.



Caution:

The old values will be overwritten by the current ones!



Caution:

When using **PH** or **DF**, the aperture diaphragm is fully open and can not be closed.

► Adjust diaphragms via

- fixed function buttons on stand
- variable function buttons on stand and SmartMove
- Leica Application Suite (LAS/LAS AF) Software

9. Trouble Shooting

Problem	Cause/Remedy
Stand	
The microscope does not respond.	<ul style="list-style-type: none">▶ Ensure that the AC outlet has power.▶ Ensure that the electronics box is connected to an AC outlet.▶ Check the cable connections.▶ Inform Service and have the supply unit fuse checked.
Illumination	
The image is completely dark.	<ul style="list-style-type: none">▶ Open the shutter (→ p. 69).▶ Check the connections of the lamp housings on the microscope (transmitted light/fluorescence)▶ Ensure that the lamps are connected to the power supply and are not defective.▶ Inform Service and have the ebq 100 supply unit fuse checked.
The image is unevenly or not uniformly illuminated.	<ul style="list-style-type: none">▶ Remove all unneeded filters from the light path.▶ Center the lamp (→ p. 79ff)▶ Replace the old lamp (→ p. 46, 50ff).
The illumination flickers.	<ul style="list-style-type: none">▶ Be sure that there is no loose connection at the power supply.▶ Replace the old lamp (→ p. 46, 50ff).
The lamp does not illuminate immediately upon being switched on.	<ul style="list-style-type: none">▶ The ebq 100 must be switched-on repeatedly.▶ Hot Hg lamps should cool down before switching on again.

Problem	Cause/Remedy
Bright field	
The specimen can not be brought into focus.	<ul style="list-style-type: none"> ▶ Use the correct immersion medium. ▶ Place the specimen on the stage with the coverslip facing down. ▶ Make sure that the cover glass thickness is correct and that it suits the indication on the objective. ▶ Ensure that you are using an objective with coverslip correction. ▶ Adjust the correction ring on the objective if present.
Dark Field	
No definite DF contrast is possible.	<ul style="list-style-type: none"> ▶ Be sure that a DF objective is being used. ▶ The objective aperture is too high: maximum 0.7 for condenser S1 maximum 0.4 for condenser S23/28 If necessary, reduce the objective aperture using the iris diaphragm on the objective. ▶ Check the condenser centering.
The image is unevenly or not uniformly illuminated.	<ul style="list-style-type: none"> ▶ The magnification is too weak. Use a higher magnification. ▶ Remove the condenser head or condenser lenses.
Undesirable stray light.	<ul style="list-style-type: none"> ▶ Clean the specimen and neighboring lenses (→ p. 110f).

9. Trouble Shooting

Problem	Cause/Remedy
Phase contrast	
No phase contrast is possible.	<ul style="list-style-type: none">▶ The specimen is too thick.▶ The cover glass is not placed evenly.▶ Check the centering of the light rings (→ p. 75).
Polarization	
No polarization contrast is possible.	<ul style="list-style-type: none">▶ Bring the polarizer and analyzer into cross position until they reach maximum darkness (without specimen). (→ p. 88).
Transmitted light interference contrast	
No transmitted light interference contrast is possible	<ul style="list-style-type: none">▶ The specimen is too thick or too thin.▶ Embedding medium or specimen are of birefringent material. Rotate the specimen.▶ The difference in the refractive indices of the specimen and the embedding medium is too small.▶ The cover glass is too thick.▶ Check the Koehler illumination (→ p. 71).▶ Bring the polarizer and analyzer into cross position until they reach maximum darkness (without specimen). (→ p. 88).▶ Check whether the suitable condenser prism and corresponding objective prism are selected (manual alternative → p. 88).▶ Ensure that the IC prisms are correctly seated (→ p. 41).

Problem	Cause/Remedy
Fluorescence	
The image is completely dark (no fluorescence).	<ul style="list-style-type: none">▶ Open the shutter (→ p. 69).▶ Select the incident light axis (IL) (→ p. 67).▶ Check your specimen, e.g. its antibody binding.▶ Insert a new lamp (→ p. 46, p.50ff).
The fluorescence is too weak.	<ul style="list-style-type: none">▶ Insert the booster (→ p. 93).▶ Center the lamp (→ p. 79ff)▶ Insert a new lamp (→ p. 46, p.50ff).
LeicaScreen	
Init Error!	<ul style="list-style-type: none">▶ Check the cable connections.▶ Check whether the cover of the filter disk has clicked into position.▶ Check the installed objectives, filter cubes, etc.▶ Switch the microscope off and back on.

10. Care of the Microscope



Caution!

Unplug the power supply before performing cleaning and maintenance work!
Protect electrical components from moisture!

Microscopes in warm and warm-damp climatic zones require special care in order to prevent fungus contamination.

The microscope should be cleaned after each use, and the microscope optics should be kept strictly clean.

10.1 Dust Cover



Note:

To protect against dust, cover the microscope and accessories with the dust cover after each use.



Caution!

Let lamps cool down before covering the stand with a dust cover. The dust cover is not heat-resistant. In addition condensation water may occur.

10.2 Cleaning



Caution:

Residual fiber and dust can create unwanted background fluorescence.

Cleaning Coated Parts

Dust and loose dirt particles can be removed with a soft brush or lint-free cotton cloth.

Clinging dirt can be cleaned as necessary with a low-concentrated soap solution, petroleum ether or ethyl alcohol.

For cleaning coated parts, use a linen or leather cloth that is moistened with one of these substances.



Caution:

Acetone, xylene or nitro-containing thinner can harm the microscope and thus must not be used.

Test cleaning solutions of unknown composition first on a less visible area of the unit. Be sure that coated or plastic surfaces do not become matted or etched.

Cleaning the stage

Rub the stage with paraffin oil or acid-free Vaseline to remove light spots on the stage.

Cleaning Glass Surfaces and Objectives

Glass surfaces, and particularly objectives, are always to be cleaned as described in the brochure "Cleaning of Microscope Optics". You can download the information from

<http://www.leica-microsystems.com/products/light-microscopes/life-science-research/inverted-microscopes>

or

<http://www.leica-microsystems.com/products/light-microscopes/clinical/inverted-microscopes>

Select the type of your microscope and switch to the "Download" page.

You can also contact our Technical Service with any questions.

Removing Immersion Oil



Caution!

Follow safety instructions for immersion oil!

First, wipe off the immersion oil with a clean cotton cloth, and then re-wipe the surface several times with ethyl alcohol.

10.3 Handling Acids and Bases

For examinations using acids or other aggressive chemicals, particular caution must be taken.



Caution:

Be absolutely certain to prevent the optics and mechanical parts from coming into contact with these chemicals.

11. Major Consumable and Replacement Parts

Order No. Material No.	Name	Used for
<u>Replacement Lamp</u>		
11 500 974	Halogen lamp 12V 100 W	107/2 lamp housing
11 500 137	High-pressure mercury burner 50 W	106 z lamp housing
11 500 138	High-pressure mercury burner 100 W	106 z lamp housing
11 500 321	High-pressure mercury burner 100 W (103 W/2)	106 z lamp housing
11 500 139	High-pressure xenon burner 75 W	106 z lamp housing
<u>Screw cap for unused objective receptacles</u>		
020-422-570-000	Screw cap M 25	Objective turret
<u>Cover for unused objective DIC disk opening</u>		
11 090-144-020-088	Cover for DIC	Microscope stand
<u>Dust and light protection cover for analyzer slot</u>		
11 020-437-101-013	Analyzer slot cover	Microscope stand
<u>Dust and light protection cover for camera port openings</u>		
11 020-387-556-009	Analyzer slot cover	Microscope stand
<u>Replacement eyecup (diaphragm protection) for HC PLAN eyepiece</u>		
021-500-017-005	HC PLAN eyecup	10x/25 eyepiece
021-264-520-018	HC PLAN eyecup	10x/22 eyepiece
021-264-520-018	HC PLAN eyecup	10x/20 eyepiece
<u>Immersion oil</u> conforming to DIN/ISO standards, fluorescence-free		
11 513 859	Type F, ISO 8036, very low autofluorescence, highly recommended for fluorescence applications and APO objectives, 10 ml	OIL and IMM objectives and oil condenser heads
11 513 860	Type N, ISO 8036, low autofluorescence, 20 ml	
11 513 861	Type N, ISO 8036, low autofluorescence, 250 ml	

12. Dimensions



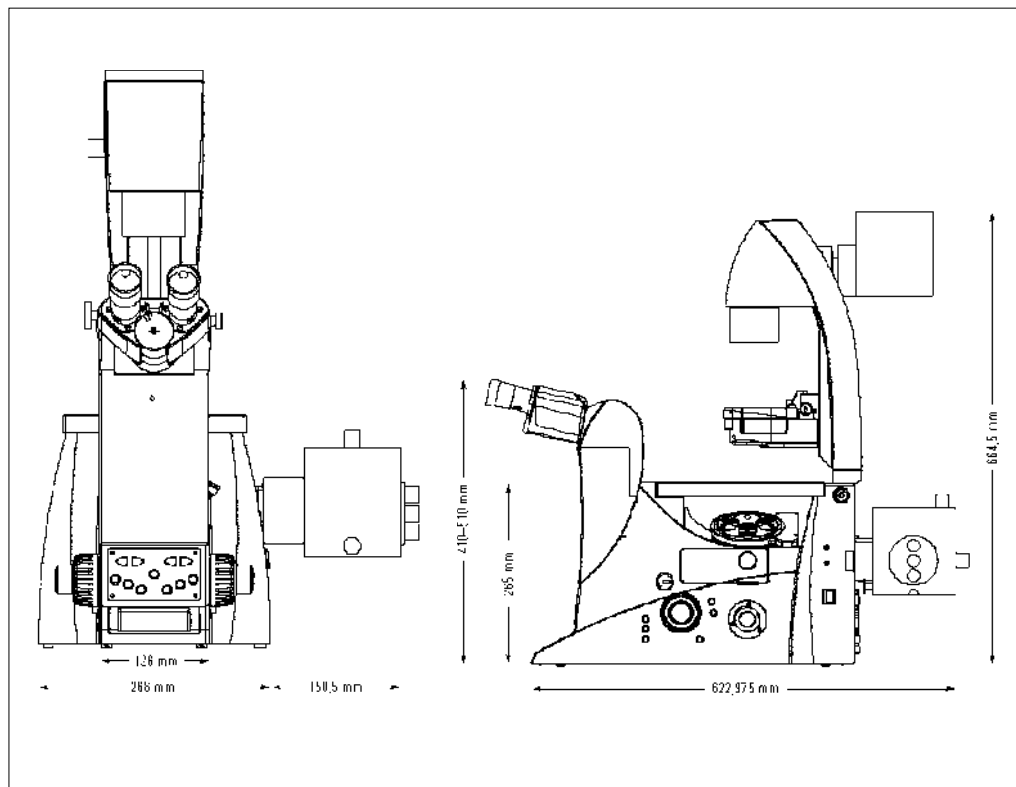













Space requirements



Height compensation plate*

A height compensation plate was developed to raise the viewing height by 20 mm or to raise the side camera ports for oversize cameras or spinning disks, or to use the microscope with an inactive bottom port on workbenches without openings.

13. Abbreviations and Pictograms

	Contrasting method
	Magnification
	Illumination
	Ports/Eyepiece
	Focus
	Lower focus stop not set
	Lower focus stop set
	Focus position not set
	Focus position set
	Shutter open
	Shutter closed
	Transmitted light filter
	Field diaphragm, rectangular
	Field diaphragm, round
	Aperture diaphragm
	Light distribution

AP	Aperture diaphragm
BF	Bright field
COMBI	Combination method
CUBE	Fluo cube
DF	Dark field incident/transmitted light
DIC	Differential Interference Contrast
FD	Field diaphragm
FLUO	Fluorescence axis (incident light)
ICR	Interference contrast, incident light
ICT	Interference contrast, transmitted light
IL	Incident light
INT	Intensity
IMC	Integrated modulation contrast
IPH	Integrated phase contrast
PH	Phase contrast
POL	Polarization, incident/transmitted light
TL	Transmitted light



www.leica-microsystems.com



Copyright © Leica Microsystems CMS GmbH · Ernst-Leitz-Straße · 35578 Wetzlar · Germany 2005 · Tel. (06441)29-0 · Fax (06441)29-2699 · LEICA and the Leica logos are registered trademarks of Leica IR GmbH.
Order nos. of the editions in: **English/German/French** 933 913 · Spanish 933 914 · Italian 933 915 · Part-No. 501-254 · Printed on chlorine-free bleached paper. XI/12/M.H.